



**QUZHOU SANYUANHUINENG ELECTRONIC CO., LTD**

Add: No.20 Donggang 8 Road Quzhou City Zhejiang Province

Tel:86-570-3666038 Fax:86-570-3666096

WEB: [www.syhn.com.cn](http://www.syhn.com.cn)

**PitBULL® HN®**

## PRODUCT MANUAL

Best to the last moment

### AC AUTOMATIC VOLTAGE REGULATOR



Professional Manufacturer  
For voltage Regulator

## COMPANY INTRODUCTION

QUZHOU SANYUAN HUINENG ELECTRONIC CO.,LTD is one of leading power solution providers with more than 20 years experience specializing in manufacturing and designing voltage regulator/stabilizer,automatic transformer,silicon core, inverters, etc.It is also the member of CPSS(China Power Supply Society) and founded in 2004, Under the guidance of ISO9001 quality managment system. Our products are not only popular in local market but also in many other countries like Africa, Mid-Asia, Mid-East countries, especially in India, Uzbekistan,Egypt, Myanmar and so on, We spend a lot of fund and energy on improving, advanced production line and testing machine for our products, This is the most important reason why we achieve high reputation and obtain at least 20 patents.

We will never stop our steps on the way to develop new products and assist our customers,OEM and ODM orders are welcomed.

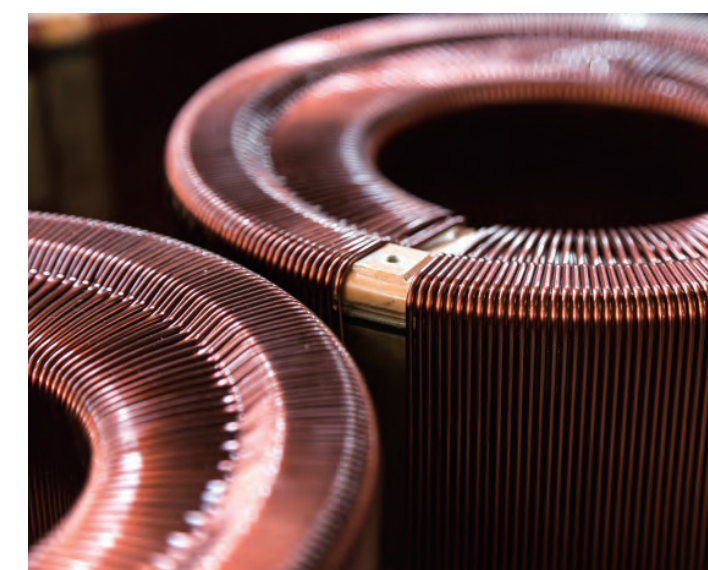
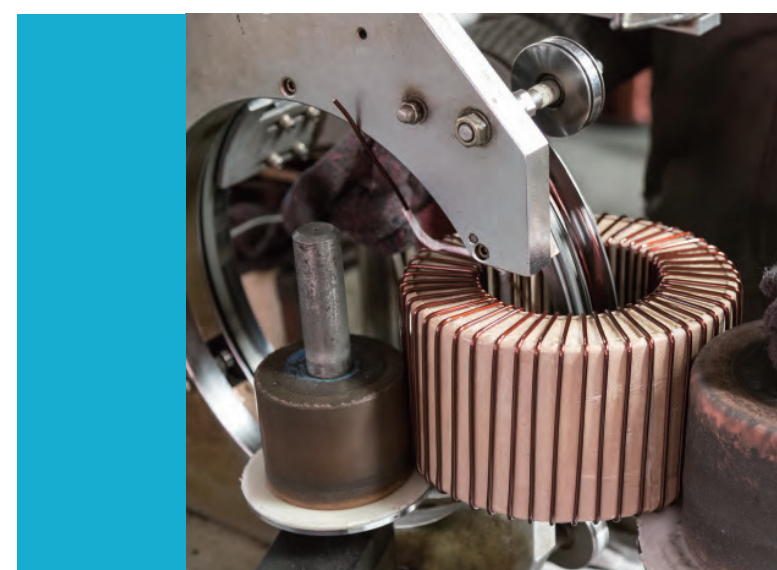

## OUR MISSION

QUALITY FOR SURVIVAL  
INNOVATION FOR GROWTH



# CONTENTS

## Relay Type

SAE/SAE95 series .....	6
SAB/SAB95 series .....	9
TMJ/TMJ95 series .....	10
SVB/SVB95 series .....	11
SVE/SVE95 series .....	13
SVR/SVR95 series .....	15
SVF/SVF95 series .....	17
SMB95 series .....	18
SMB45/SMB60/SMB95 series .....	19
TMB/TMB95 series .....	23
TMB/TMB45/TMB60/TMB95 series .....	24
TML/TML95 series .....	27
TMH45/TMH60/TMH95 series .....	29

TM/TM45/TM60/TM95 series .....	32
TME/TME95 series .....	33
TMG/TMG95 series .....	35

## Servo Motor Type

SVC50 series .....	36
SVC series .....	37
SVC-M series .....	39
PC-SVC series .....	41
TND series .....	43
TNS series .....	45
TNS-B series .....	47
SBW series .....	49

# AC AUTOMATIC VOLTAGE REGULATOR



RELAY TYPE

## SAE/SAE95 series (500VA-2000VA)

### PRODUCT FEATURES

The product of this model is a 220V fully automatic small-sized voltage regulator, which is a portable LED digital display design. It is characterized by small size, light weight, high voltage regulation speed and no waveform distortion.

### APPLICATION

It is widely used in various industries, small office equipment, refrigerator, electric fan, TV set, computer and other household appliances.

### PRODUCTS SPECIFICATION

MODEL	SAE (500VA-2000VA)		SAE95 (500VA-2000VA)	
INPUT VOLTAGE	AC 130V-270V		AC 95V-270V	
OUTPUT VOITAGE	AC 220V±10% 50/60Hz			
DELAY TIME	Short Delay:3-5sec Long Deley:3-7min			
PROTECTION	Over Voltage(246V±4V),Overload,High Temperature,Short Circuit			
POWER	500VA	1000VA	1500VA	2000VA
PRODUCT SIZE(CM)	30x15.5x20	30x15.5x20	30x15.5x20	30x15.5x20
PACKING SIZE(CM)	39.5x35x50	39.5x35x50	39.5x35x50	39.5x35x50
PCS/CARTON	4	4	4	4
N.W.(KGS)	10.3	13.3	17.5	20
G.W.(KGS)	12.3	15.3	19.5	21.9



### FUNCTION DISPLAY

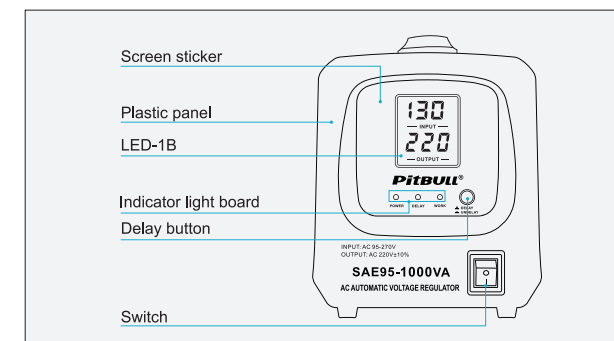

FRONT PANEL

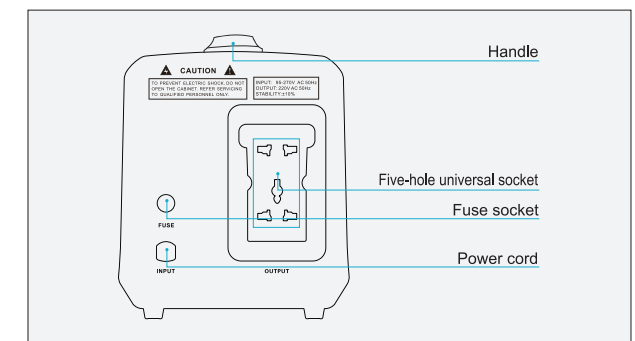

BACK PANEL



Relay Control+Toroidal Transformer, Efficiency >97%



**Pitbull®**

- NATIONAL HIGH-TECH ENTERPRISE
- CERTIFICATE OF ENVIRONMENT MANAGEMENT SYSTEM
- QUALITY MANAGEMENT SYSTEM CERTIFICATION CERTIFICATE
- CERTIFICATE OF OCCUPATIONAL HEALTH AND SAFETY MANAGEMENT SYSTEM

# SAE/SAE95 series (3000VA-5000VA)

## PRODUCT FEATURES

The product of this model is a 220V fully automatic voltage regulator, with LED digital display design, USB charging interface, it is characterized by stable work, high pressure regulation speed and wide range.

## APPLICATION

It is widely used in various industries, small office equipment, refrigerator, electric fan, computer, pump, air conditioner and other household appliances.

## PRODUCTS SPECIFICATION



MODEL	SAE (3000VA-5000VA)	SAE95 (3000VA-5000VA)
INPUT VOLTAGE	AC 130V-270V	AC 95V-270V
OUTPUT VOITAGE	AC 220V±10% 50/60Hz	
DELAY TIME	Short Delay:3-5sec Long Deley:3-7min	
PROTECTION	Over Voltage(246V±4V),Overload,High Temperature,Short Circuit	
POWER	3000VA	5000VA
PRODUCT SIZE(CM)	38.1x22x26.5	38.1x22x26.5
PACKING SIZE(CM)	46x27.5x32.5	46x27.5x32.5
PCS/CARTON	1	1
N.W.(KGS)	11.2	15.4
G.W.(KGS)	12.4	16.6



## FUNCTION DISPLAY

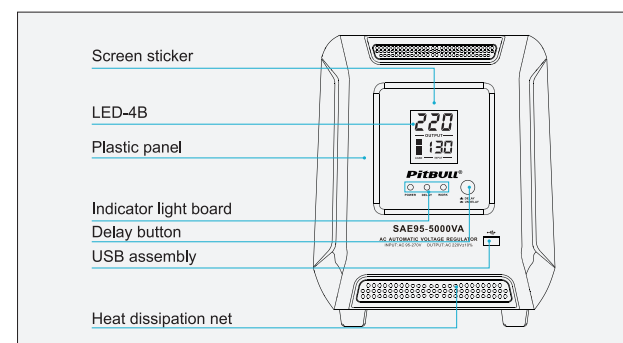

FRONT PANEL

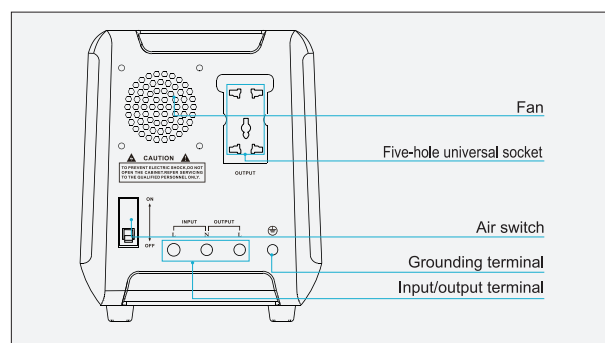

BACK PANEL



Relay Control+Toroidal Transformer, Efficiency > 97%

# SAE/SAE95 series (8000VA-20kVA)

## PRODUCT FEATURES

The product of this model is a 220V fully automatic voltage regulator, with LED digital display design, USB charging interface, it is characterized by stable lower voltage, high pressure regulation speed, wide range and high efficiency.

## APPLICATION

It is widely used in various industries, small office equipment, refrigerator, electric fan, computer, pump, air conditioner and other household appliances.

## PRODUCTS SPECIFICATION



MODEL	SAE (8000VA-20kVA)		SAE95 (8000VA-20kVA)	
INPUT VOLTAGE	AC 130V-270V		AC 95V-280V	
OUTPUT VOITAGE	AC 220V±10% 50/60Hz			
DELAY TIME	Short Delay:3-5sec Long Deley:3-7min			
PROTECTION	Over Voltage(246V±4V),Overload,High Temperature,Short Circuit			
POWER	8000VA	10000VA	15000VA	20000VA
PRODUCT SIZE(CM)	46.2x26.6x33.4	46.2x26.6x33.4	46.2x26.6x33.4	50.1x26.6x33.4
PACKING SIZE(CM)	52x32.5x37.5	52x32.5x37.5	52x32.5x37.5	56x32.5x37.5
PCS/CARTON	1	1	1	1
N.W.(KGS)	20	23.3	26.6	29.9
G.W.(KGS)	21.3	24.6	27.9	31.5



## FUNCTION DISPLAY

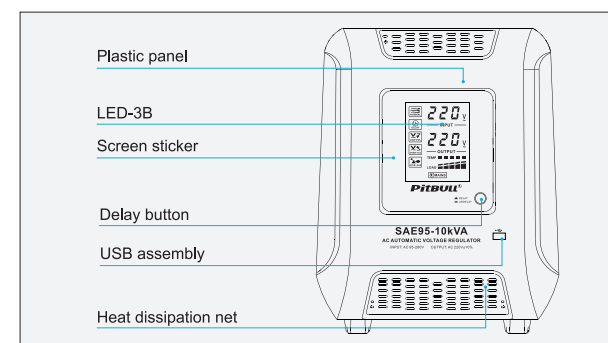

FRONT PANEL

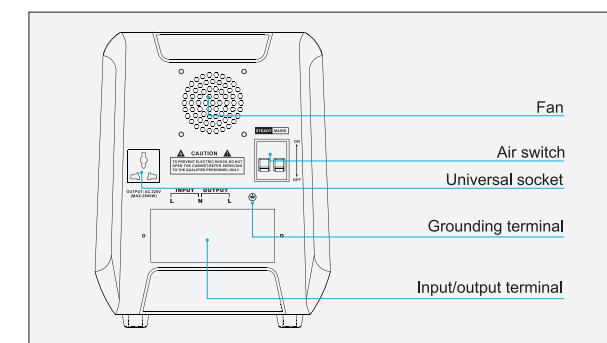

BACK PANEL



Relay Control+Toroidal Transformer, Efficiency > 97%

# SAB/SAB95 series (500VA-2000VA)

## PRODUCT FEATURES

The product of this model is a 220V fully automatic small-sized voltage regulator, which is a portable LCD digital display design. It is characterized by relay switching gear, high voltage regulation speed and wide range.

## APPLICATION

It is widely used in various industries, small office equipment, refrigerator, electric fan, TV set, computer and other household appliances.

## PRODUCTS SPECIFICATION



MODEL	SAB (500VA-2000VA)		SAB95 (500VA-2000VA)	
INPUT VOLTAGE	AC 130V-270V		AC 95V-270V	
OUTPUT VOITAGE	AC 220V±10% 50/60Hz			
DELAY TIME	Short Delay:3-5sec Long Deley:3-7min			
PROTECTION	Over Voltage(246V±4V),Overload,High Temperature,Short Circuit			
POWER	500VA	1000VA	1500VA	2000VA
PRODUCT SIZE(CM)	30x15.5x20	30x15.5x20	30x15.5x20	30x15.5x20
PACKING SIZE(CM)	39.5x35x50	39.5x35x50	39.5x35x50	39.5x35x50
PCS/CARTON	4	4	4	4
N.W.(KGS)	10.3	13.6	18.9	20.2
G.W.(KGS)	12.3	15.8	20.5	24



## FUNCTION DISPLAY

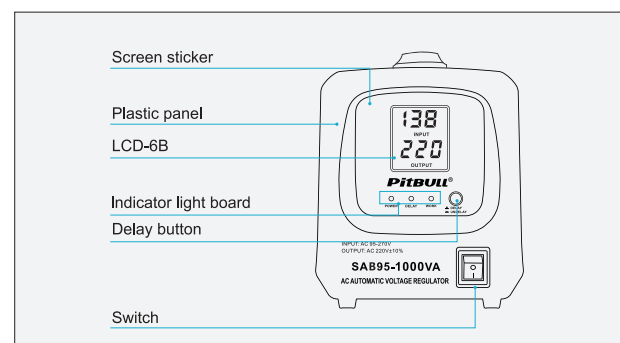

FRONT PANEL

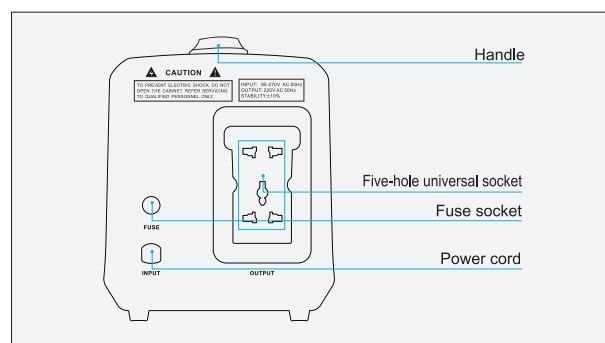

BACK PANEL



Relay Control+Toroidal Transformer, Efficiency >97%

# TMJ/TMJ95 series (500VA-2000VA)

## PRODUCT FEATURES

The product of this model is a 220V fully automatic small-sized voltage regulator, which is a portable LCD digital display design. It is characterized by relay switching gear, high voltage regulation speed and wide range.

## APPLICATION

It is widely used in various industries, small office equipment, refrigerator, electric fan, TV set, computer and other household appliances.

## PRODUCTS SPECIFICATION



MODEL	TMJ(500VA-2000VA)		TMJ95 (500VA-2000VA)	
INPUT VOLTAGE	AC 130V-270V		AC 95V-270V	
OUTPUT VOITAGE	AC 220V±10% 50/60Hz			
DELAY TIME	Short Delay:3-5secA			
PROTECTION	Over Voltage(246V±4V),Overload,High Temperature,Short Circuit			
POWER	500VA	1000VA	1500VA	2000VA
PRODUCT SIZE(CM)	28x16.2x9.5	28x16.2x9.5	28x16.2x9.5	32.4x18.2x10.4
PACKING SIZE(CM)	63.5x36x30	63.5x36x30	63.5x36x30	70x38.5x32.5
PCS/CARTON	6	6	6	6
N.W.(KGS)	15.2	19.7	26.6	31.8
G.W.(KGS)	17.6	21.8	29	35.3



## FUNCTION DISPLAY

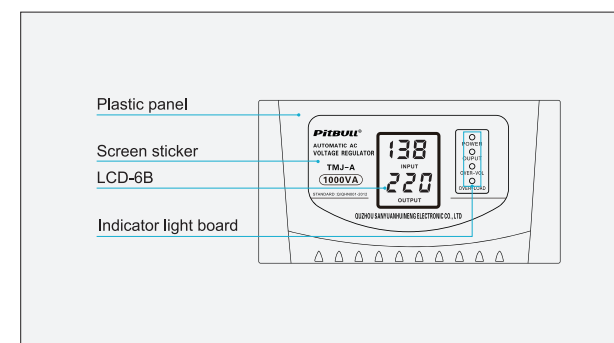

FRONT PANEL

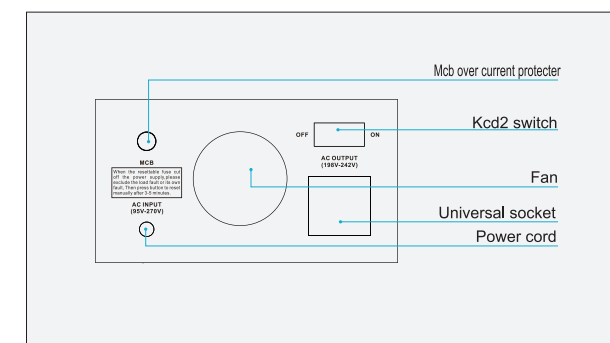

BACK PANEL



Relay Control+Toroidal Transformer, Efficiency >97%

# SVB/SVB95 series (1000VA-2000VA)

## PRODUCT FEATURES

The product of this model is a 220V fully automatic small-sized voltage regulator, retro style and portable LCD display design. It is characterized by small size, light weight and high pressure regulation speed.

## APPLICATION

It is widely used in various industries, small office equipment, refrigerator, electric fan, TV set, computer and other household appliances.

## PRODUCTS SPECIFICATION



MODEL	SVB(1000VA-2000VA)	SVB95(1000VA-2000VA)
INPUT VOLTAGE	AC 130V-270V	AC 95V-270V
OUTPUT VOITAGE	AC 220V±10% 50/60Hz	
DELAY TIME	Short Delay:3-5sec Long Delay:3-7min	
PROTECTION	Over Voltage(246V±4V),Overload,High Temperature,Short Circuit	
POWER	1000VA	1500VA 2000VA
PRODUCT SIZE(CM)	28.5x15x19	28.5x15x19
PACKING SIZE(CM)	60x33x45	60x33x45
PCS/CARTON	6	6
N.W.(KGS)	22.4	29.4
G.W.(KGS)	25.3	32.3



## FUNCTION DISPLAY

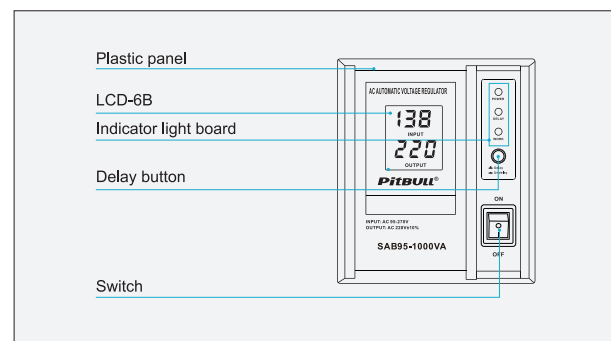

FRONT PANEL

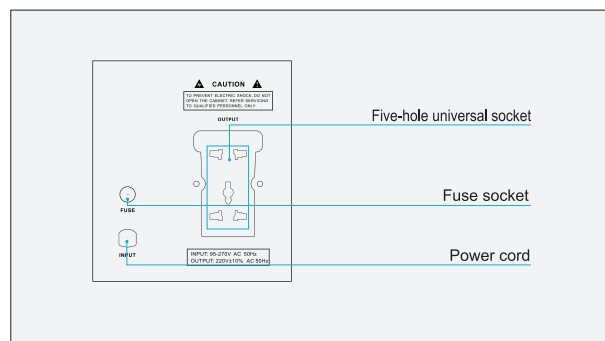

BACK PANEL



Relay Control+Toroidal Transformer, Efficiency > 97%



# SVB/SVB95 series (3000VA-5000VA)

## PRODUCT FEATURES

The product of this model is a 220V fully automatic voltage regulator, with LCD display design. It is characterized by stable work, high pressure regulation speed and wide voltage regulation range.

## APPLICATION

It is widely used in various industries, small office equipment, refrigerator, electric fan, computer, pump, air conditioner and other household appliances.

## PRODUCTS SPECIFICATION



MODEL	SVB(3000VA-5000VA)	SVB95(3000VA-5000VA)
INPUT VOLTAGE	AC 130V-270V	AC 95V-270V
OUTPUT VOITAGE	AC 220V±10% 50/60Hz	
DELAY TIME	Short Delay:3-5sec Long Delay:3-7min	
PROTECTION	Over Voltage(246V±4V),Overload,High Temperature,Short Circuit	
POWER	3000VA	5000VA
PRODUCT SIZE(CM)	38.5x21.5x25.5	38.5x21.5x25.5
PACKING SIZE(CM)	42.5x26.5x29	42.5x26.5x29
PCS/CARTON	1	1
N.W.(KGS)	10.2	11.4
G.W.(KGS)	11	12.2



## FUNCTION DISPLAY

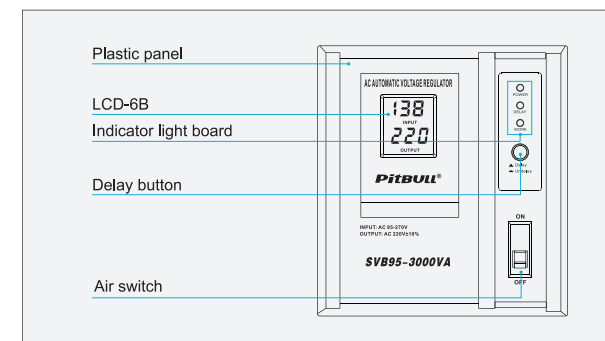

FRONT PANEL

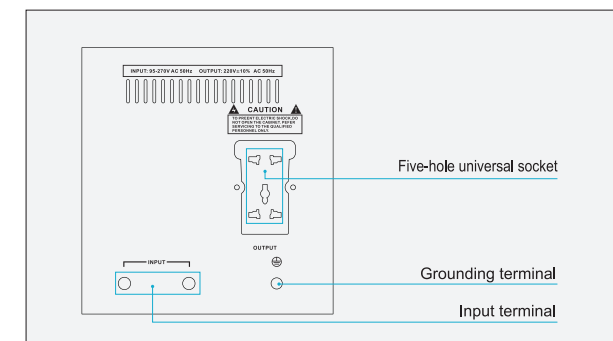

BACK PANEL



Relay Control+Toroidal Transformer, Efficiency > 97%

# SVE/SVE95 series (1000VA-2000VA)

## PRODUCT FEATURES

The product of this model is a 220V fully automatic small-sized voltage regulator, with portable LED display design. It is characterized by small size, light weight and high pressure regulation speed.

## APPLICATION

It is widely used in various industries, small office equipment, refrigerator, electric fan, TV set, computer and other household appliances.

## PRODUCTS SPECIFICATION



MODEL	SVE(1000VA-2000VA)	SVE95(1000VA-2000VA)
INPUT VOLTAGE	AC 130V-270V	AC 95V-270V
OUTPUT VOITAGE	AC 220V±10% 50/60Hz	
DELAY TIME	Short Delay:3-5sec Long Delay:3-7min	
PROTECTION	Over Voltage(246V±4V),Overload,High Temperature,Short Circuit	
POWER	1000VA	1500VA 2000VA
PRODUCT SIZE(CM)	28.5x15x19	28.5x15x19
PACKING SIZE(CM)	60x33x45	60x33x45
PCS/CARTON	6	6
N.W.(KGS)	22.4	29.4
G.W.(KGS)	25.3	32.3



## FUNCTION DISPLAY

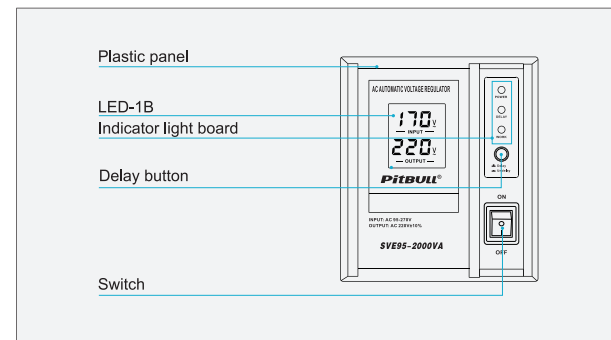

FRONT PANEL

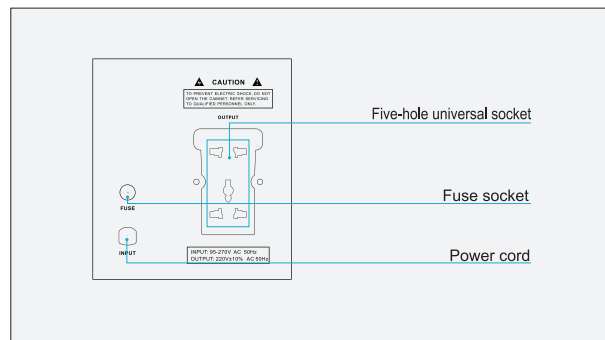

BACK PANEL



Relay Control+Toroidal Transformer, Efficiency > 97%

# SVE/SVE95 series (3000VA-5000VA)

## PRODUCT FEATURES

The product of this model is a 220V fully automatic voltage regulator, with LED display design. It is characterized by stable work, high pressure regulation speed and wide voltage regulation range.

## APPLICATION

It is widely used in various industries, small office equipment, refrigerator, electric fan, computer, pump, air conditioner and other household appliances.

## PRODUCTS SPECIFICATION



MODEL	SVE(3000VA-5000VA)	SVE95(3000VA-5000VA)
INPUT VOLTAGE	AC 130V-270V	AC 95V-270V
OUTPUT VOITAGE	AC 220V±10% 50/60Hz	
DELAY TIME	Short Delay:3-5sec Long Delay:3-7min	
PROTECTION	Over Voltage(246V±4V),Overload,High Temperature,Short Circuit	
POWER	3000VA	5000VA
PRODUCT SIZE(CM)	38.5x21.5x25.3	38.5x21.5x25.3
PACKING SIZE(CM)	42.5x26.5x29	42.5x26.5x29
PCS/CARTON	1	1
N.W.(KGS)	9.5	12.8
G.W.(KGS)	10.3	13.6



## FUNCTION DISPLAY

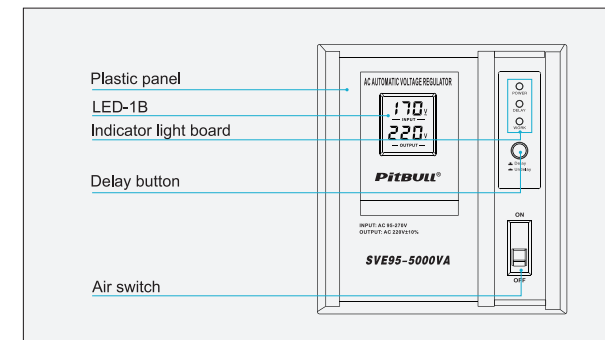

FRONT PANEL

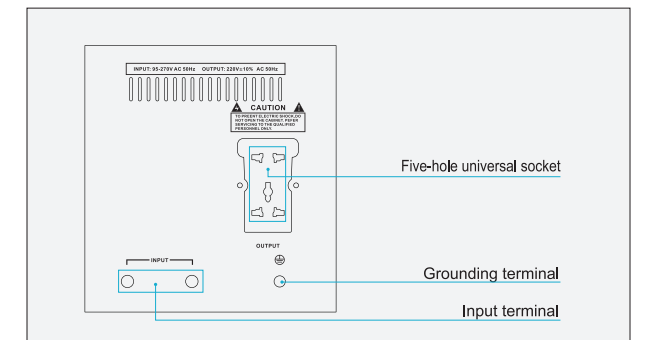

BACK PANEL



Relay Control+Toroidal Transformer, Efficiency > 97%



# SVR/SVR95 series (500VA-2000VA)

## PRODUCT FEATURES

The product of this model is a 220V fully automatic small-sized voltage regulator, retro style and portable pointer display design. It is characterized by small size, light weight and high pressure regulation speed.

## APPLICATION

It is widely used in various industries, small office equipment, refrigerator, electric fan, TV set, computer and other household appliances.

## PRODUCTS SPECIFICATION



MODEL	SVR(500VA-2000VA)		SVR95(500VA-2000VA)	
INPUT VOLTAGE	AC 130V-270V		AC 95V-270V	
OUTPUT VOITAGE	AC 220V±10% 50/60Hz			
DELAY TIME	Short Delay:3-5sec Long Delay:3-7min			
PROTECTION	Over Voltage(246V±4V),Overload,High Temperature,Short Circuit			
POWER	500VA	1000VA	1500VA	2000VA
PRODUCT SIZE(CM)	25.5x11x16	28.5x15x18.9	28.5x15x18.9	28.5x15x18.9
PACKING SIZE(CM)	63.2x31.5x39	60x33x45	60x33x45	60x33x45
PCS/CARTON	8	6	6	6
N.W.(KGS)	20	22.4	29.4	32
G.W.(KGS)	22.8	25.3	32.3	34.9



## FUNCTION DISPLAY

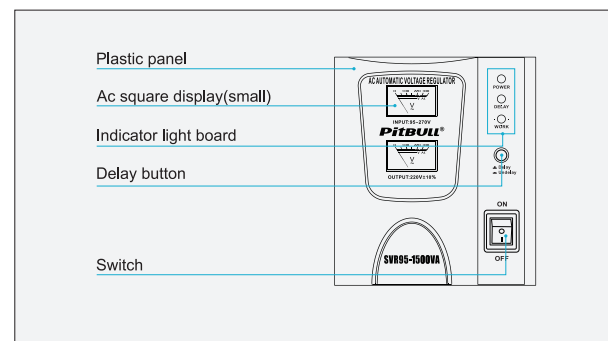

FRONT PANEL

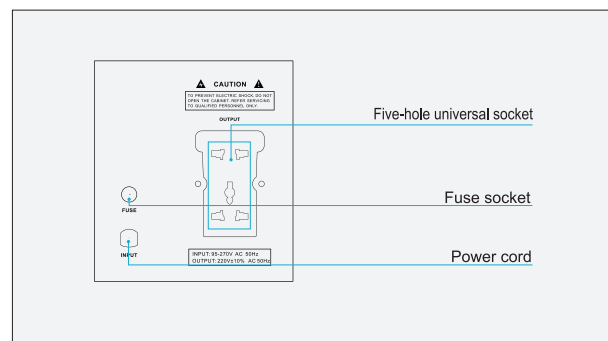

BACK PANEL



Relay Control+Toroidal Transformer, Efficiency > 97%

# SVR/SVR95 series (3000VA-5000VA)

## PRODUCT FEATURES

The product of this model is a 220V fully automatic voltage regulator, retro style and pointer display design. It is characterized by stable work, high pressure regulation speed and wide voltage regulation range.

## APPLICATION

It is widely used in various industries, small office equipment, refrigerator, electric fan, computer, pump, air conditioner and other household appliances.

## PRODUCTS SPECIFICATION



MODEL	SVR(3000VA-5000VA)		SVR95(3000VA-5000VA)	
INPUT VOLTAGE	AC 130V-270V		AC 95V-270V	
OUTPUT VOITAGE	AC 220V±10% 50/60Hz			
DELAY TIME	Short Delay:3-5sec Long Delay:3-7min			
PROTECTION	Over Voltage(246V±4V),Overload,High Temperature,Short Circuit			
POWER	3000VA		5000VA	
PRODUCT SIZE(CM)	38.5x21.5x25.5		38.5x21.5x25.5	
PACKING SIZE(CM)	42.5x26.5x29		42.5x26.5x29	
PCS/CARTON	1		1	
N.W.(KGS)	10.2		11.6	
G.W.(KGS)	11		12.2	



## FUNCTION DISPLAY

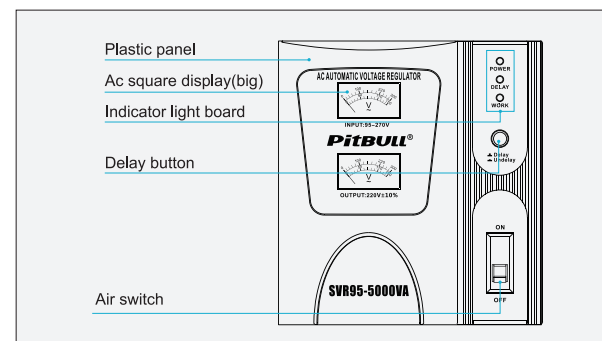

FRONT PANEL

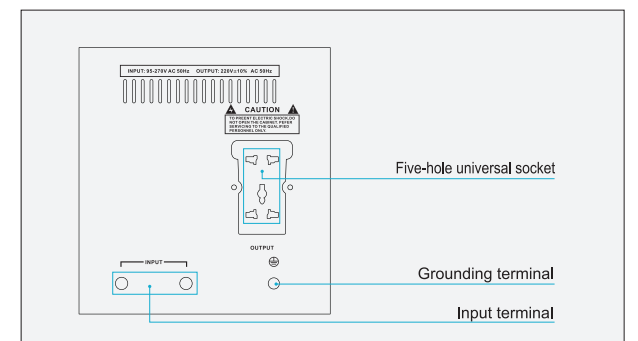

BACK PANEL



Relay Control+Toroidal Transformer, Efficiency > 97%

# SVF/SVF95 series (3000VA-5000VA)

## PRODUCT FEATURES

The product of this model is a 220V fully automatic voltage regulator, which is a portable LED digital display design. With self-protection function. It is characterized by stable work, high voltage regulation speed, no waveform distortion and strong instant overload ability.

## APPLICATION

It is widely used in various industries, small office equipment, refrigerator, electric fan, computer, pump, air conditioner and other household appliances.

## PRODUCTS SPECIFICATION



MODEL	SVF series (3000VA-5000VA)	SVF95 series (3000VA-5000VA)
INPUT VOLTAGE	AC 130V-270V	AC 95V-270V
OUTPUT VOITAGE	AC 220V±10% 50/60Hz	
DELAY TIME	Short Delay:3-5sec Long Deley:3-7min	
PROTECTION	Over Voltage(246V±4V),Overload,High Temperature,Short Circuit	
POWER	3000VA	5000VA
PRODUCT SIZE(CM)	38.5x21.5x25.5	38.5x21.5x25.5
PACKING SIZE(CM)	42.5x26.5x29	42.5x26.5x29
PCS/CARTON	1	1
N.W.(KGS)	10.2	11.6
G.W.(KGS)	11	12.3



## FUNCTION DISPLAY

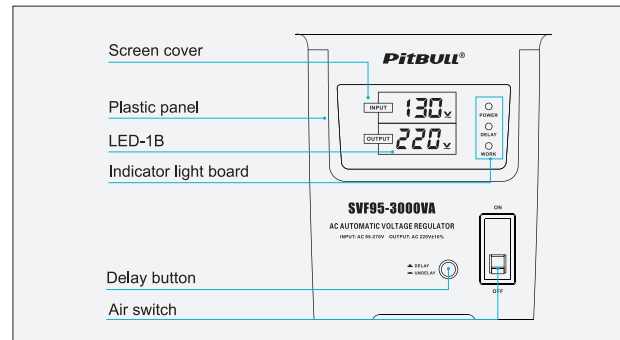

FRONT PANEL

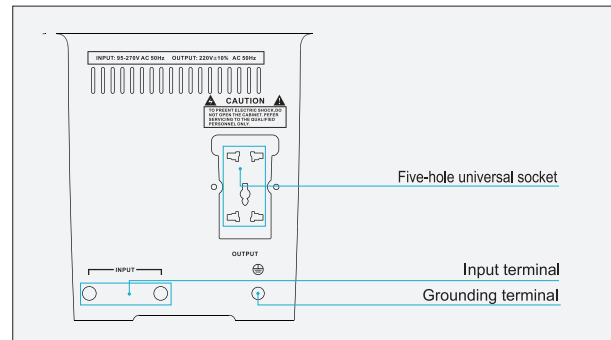

BACK PANEL



Relay Control+Toroidal Transformer, Efficiency > 97%

# SMB95 series (500VA-2000VA)

## PRODUCT FEATURES

The product of this model is a 220V fully automatic small-sized voltage regulator, both for desktop and wall mounted. With LED digital display design. It is characterized by small size, light weight, easy to use and install, reliable operation and high pressure regulation speed.

## APPLICATION

It is widely used in various industries, small office equipment, refrigerator, electric fan, TV set, computer and other household appliances.

## PRODUCTS SPECIFICATION



MODEL	SMB95 (500VA-2000VA)			
INPUT VOLTAGE	AC 95V-270V			
OUTPUT VOITAGE	AC 220V±10% 50/60Hz			
DELAY TIME	Short Delay:3-5sec Long Deley:3-7min			
PROTECTION	Over Voltage(246V±4V),Overload,High Temperature,Short Circuit			
POWER	500VA	1000VA	1500VA	2000VA
PRODUCT SIZE(CM)	17.5x16.5x12	17.5x16.5x12	24x16.5x12	24x16.5x12
PACKING SIZE(CM)	41.4x25.8x35	41.4x25.8x35	41.4x32.2x35	41.4x32.2x35
PCS/CARTON	4	4	4	4
N.W.(KGS)	12.8	15	18.8	24.5
G.W.(KGS)	14.6	16.4	20.6	26.5

## FUNCTION DISPLAY

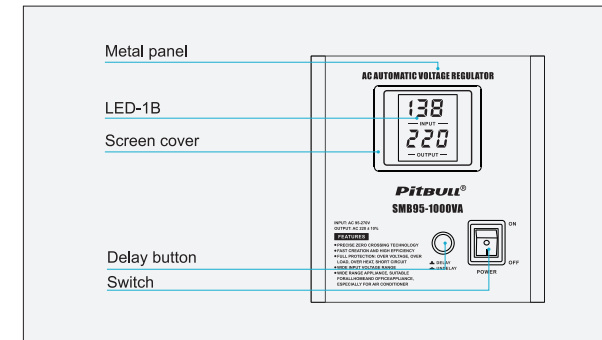

FRONT PANEL

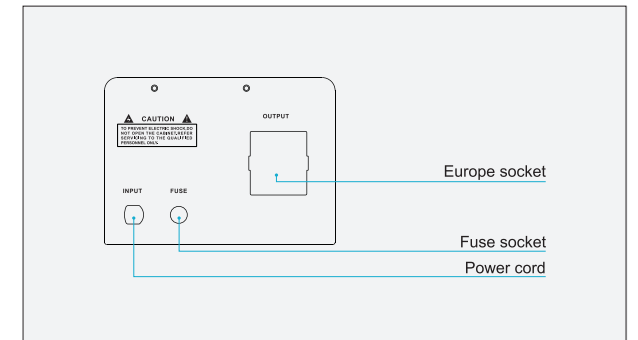

TOP



Relay Control+Toroidal Transformer, Efficiency > 97%

# SMB45/SMB60/SMB95 series (3000VA-20kVA)

## PRODUCT FEATURES

The product of this model is a 220V fully automatic voltage regulator, both for desktop and wall mounted. With concise and generous design, multiple screen optional. It is characterized by stable work, high pressure regulation speed and wide voltage regulation range.

## PRODUCTS SPECIFICATION



MODEL	SMB95-3000VA		
INPUT VOLTAGE	AC 45V-270V	AC 60V-270V	AC 95V-270V
OUTPUT VOITAGE	AC 220V±10% 50/60Hz		
DELAY TIME	Short Delay:3-5sec Long Deley:3-7min		
PROTECTION	Over Voltage(246V±4V),Overload,High Temperature,Short Circuit		
POWER	3000VA		
PRODUCT SIZE(CM)	33x24x14		
PACKING SIZE(CM)	38x29x19		
PCS/CARTON	1		
N.W.(KGS)	11.2		
G.W.(KGS)	11.8		



MODEL	SMB45-5000VA	SMB60-5000VA	SMB95-5000VA
INPUT VOLTAGE	AC 45V-280V	AC 60V-280V	AC 95V-280V
OUTPUT VOITAGE	AC 220V±10% 50/60Hz		
DELAY TIME	Short Delay:3-5sec Long Deley:3-7min		
PROTECTION	Over Voltage(246V±4V),Overload,High Temperature,Short Circuit		
POWER	5000VA		
PRODUCT SIZE(CM)	36.5x27x17.5		
PACKING SIZE(CM)	41.5x32x23		
PCS/CARTON	1		
N.W.(KGS)	15.4		
G.W.(KGS)	16.3		



Relay Control+Toroidal Transformer, Efficiency > 97%



## APPLICATION

It is Widely used in various industries, small office equipment and refrigerators, electric fans, air conditioning, television and other small appliances.

## PRODUCTS SPECIFICATION



MODEL	SMB45(8000VA-12kVA)	SMB60(8000VA-12kVA)	SMB95(8000VA-12kVA)
INPUT VOLTAGE	AC 45V-280V	AC 60V-280V	AC 95V-280V
OUTPUT VOITAGE	AC 220V±10% 50/60Hz		
DELAY TIME	Short Delay:3-5sec Long Deley:3-7min		
PROTECTION	Over Voltage(246V±4V),Overload,High Temperature,Short Circuit		
POWER	8000VA	10000VA	12000VA
PRODUCT SIZE(CM)	39.5x30x19	39.5x30x19	39.5x30x19
PACKING SIZE(CM)	45x35x25	45x35x25	45x35x25
PCS/CARTON	1	1	1
N.W.(KGS)	20	22.6	23.3
G.W.(KGS)	21.1	23.8	24

## FUNCTION DISPLAY

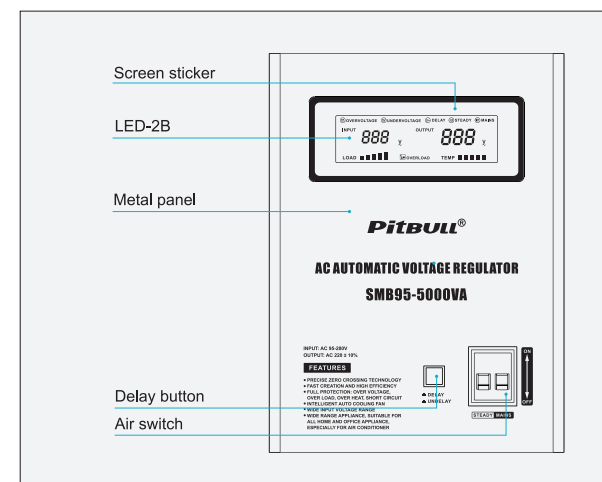

FRONT PANEL

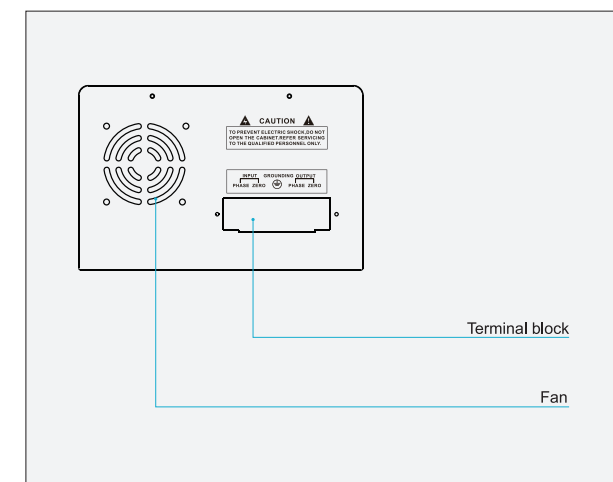

TOP



Relay Control+Toroidal Transformer, Efficiency > 97%

# 220V FULLY AUTOMATIC VOLTAGE REGULATOR

both for desktop and wall mounted



It is widely used in various industries, small office equipment, refrigerator, electric fan, computer, pump, air conditioner and other household appliances.



## SMB45/SMB60/SMB95 series (3000VA-20kVA)

### PRODUCTS SPECIFICATION



MODEL	SMB45(15kVA/20kVA)	SMB60(15kVA/20kVA)	SMB95(15kVA/20kVA)
INPUT VOLTAGE	AC 45V-280V	AC 60V-280V	AC 95V-280V
OUTPUT VOLTAGE	AC 220V±10% 50/60Hz		
DELAY TIME	Short Delay:3-5sec Long Deley:3-7min		
PROTECTION	Over Voltage(246V±4V),Overload,High Temperature,Short Circuit		
POWER	15000VA	20000VA	
PRODUCT SIZE(CM)	30x27x42.5	30x27x42.5	
PACKING SIZE(CM)	40x36.5x51.5	40x36.5x51.5	
PCS/CARTON	1	1	
N.W.(KGS)	30.1	32.5	
G.W.(KGS)	32	34	

### FUNCTION DISPLAY

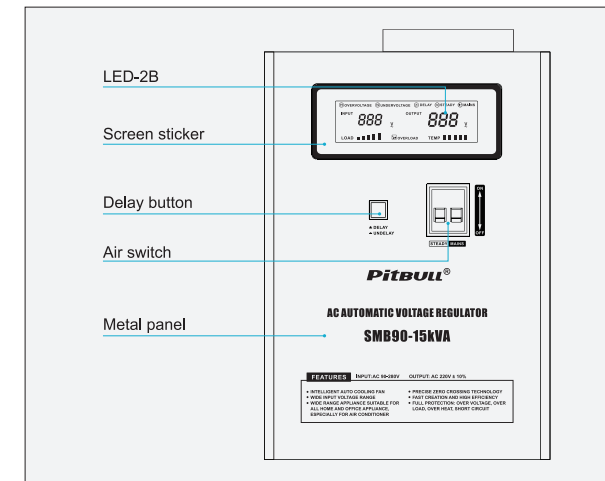

FRONT PANEL

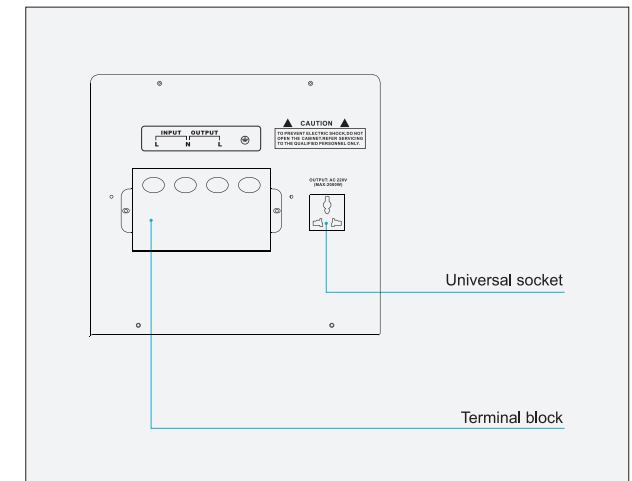

TOP



Relay Control+Toroidal Transformer, Efficiency > 97%

## TMB/TMB95 series (500VA-2000VA)

### PRODUCT FEATURES

The product of this model is a 220V fully automatic small-sized voltage regulator, both for desktop and wall mounted. With LED digital display design. It is characterized by small size, light weight, easy to use and install, reliable operation and high pressure regulation speed.

### APPLICATION

It is widely used in various industries, small office equipment, refrigerator, electric fan, TV set, computer and other household appliances.

### PRODUCTS SPECIFICATION



MODEL	TMB(1000VA-2000VA)		TMB95(1000VA-2000VA)	
INPUT VOLTAGE	AC 130V-270V		AC 95V-280V	
OUTPUT VOITAGE	AC 220V±10% 50/60Hz			
DELAY TIME	Short Delay:3-5sec Long delay:3-7min			
PROTECTION	Over Voltage(246V±4V),Overload,High Temperature,Short Circuit			
POWER	500VA	1000VA	1500VA	2000VA
PRODUCT SIZE(CM)	17.5x16.5x12	17.5x16.5x12	17.5x16.5x12	24x16.5x12
PACKING SIZE(CM)	52.5x27x39	52.5x27x39	52.5x27x39	53x33.6x39
PCS/CARTON	4	4	4	4
N.W.(KGS)	12.8	15.6	18.8	23.9
G.W.(KGS)	14.6	16.4	20.6	26.5

### FUNCTION DISPLAY

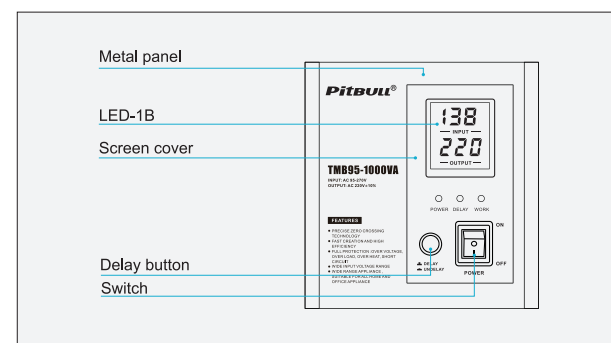

FRONT PANEL

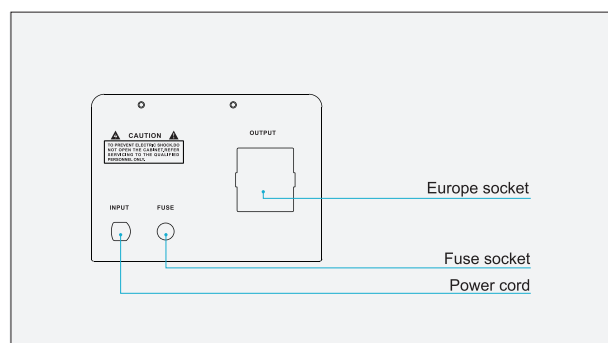

TOP



Relay Control+Toroidal Transformer, Efficiency > 97%

## TMB/TMB45/TMB60/TMB95 series (3000VA-12kVA)

### PRODUCT FEATURES

The product of this model is a 220V fully automatic voltage regulator, both for desktop and wall mounted. With LED digital display design. It is characterized by stable work, high pressure regulation speed and wide voltage regulation range.

### PRODUCTS SPECIFICATION



MODEL	TMB-3000VA		TMB95-3000VA	
INPUT VOLTAGE	AC 130V-270V	AC 45V-270V	AC 60V-270V	AC 95V-270V
OUTPUT VOLTAGE	AC 220V±10% 50/60Hz			
DELAY TIME	Short Delay:3-5sec Long Delay:3-7min			
PROTECTION	Over Voltage(246V±4V),Overload,High Temperature,Short Circuit			
POWER	3000VA			
PRODUCT SIZE(CM)	33x24x14			
PACKING SIZE(CM)	38.5x33.5x21.2			
PCS/CARTON	1			
N.W.(KGS)	11.2			
G.W.(KGS)	11.8			



MODEL	TMB-5000VA	TMB45-5000VA	TMB60-5000VA	TMB95-5000VA
INPUT VOLTAGE	AC 130V-270V	AC 45V-280V	AC 60V-280V	AC 95V-280V
OUTPUT VOLTAGE	AC 220V±10% 50/60Hz			
DELAY TIME	Short Delay:3-5sec Long Delay:3-7min			
PROTECTION	Over Voltage(246V±4V),Overload,High Temperature,Short Circuit			
POWER	5000VA			
PRODUCT SIZE(CM)	36.5x27x17.5			
PACKING SIZE(CM)	41.5x36.5x24.5			
PCS/CARTON	1			
N.W.(KGS)	15.7			
G.W.(KGS)	16.3			



Relay Control+Toroidal Transformer, Efficiency > 97%

**APPLICATION**

It is widely used in various industries, small office equipment, refrigerator, electric fan, computer, pump, air conditioner and other household appliances.

**PRODUCTS SPECIFICATION**



MODEL	TMB(8000VA-12kVA)	TMB45(8000VA-12kVA)	TMB60(8000VA-12kVA)	TMB95(8000VA-12kVA)
INPUT VOLTAGE	AC 130V-270V	AC 45V-280V	AC 60V-280V	AC 95V-280V
OUTPUT VOLTAGE	AC 220V±10% 50/60Hz			
DELAY TIME	Short Delay:3-5sec Long Deley:3-7min			
PROTECTION	Over Voltage(246V±4V),Overload,High Temperature,Short Circuit			
POWER	8000VA	10000VA	12000VA	
PRODUCT SIZE(CM)	39.5x30x19	39.5x30x19	39.5x30x19	
PACKING SIZE(CM)	45x39.5x25.7	45x39.5x25.7	45x39.5x25.7	
PCS/CARTON	1	1	1	
N.W.(KGS)	20	22.6	23.3	
G.W.(KGS)	21.1	25.2	24.4	

**FUNCTION DISPLAY**

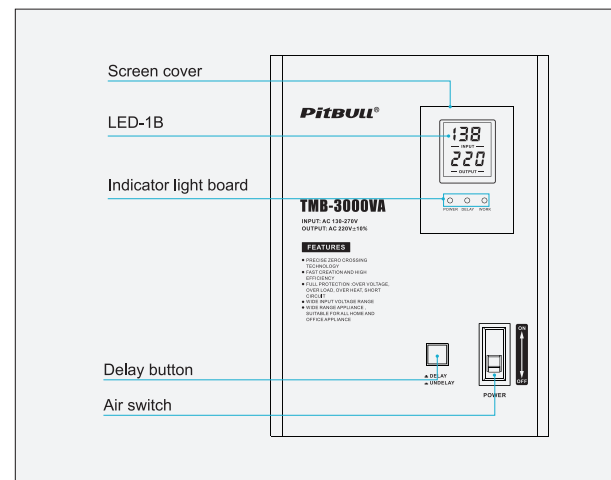

FRONT PANEL

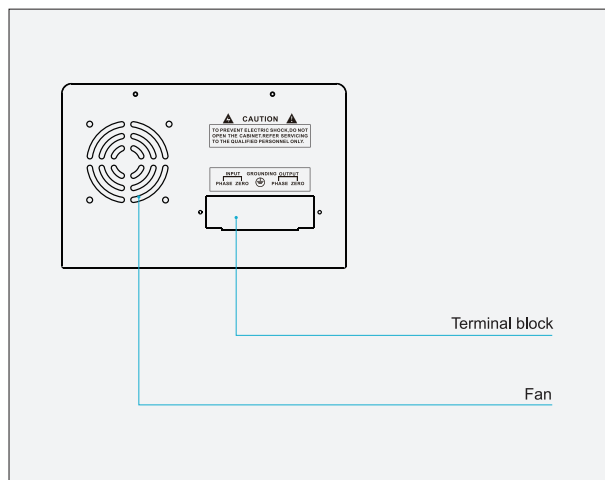

TOP



Relay Control+Toroidal Transformer, Efficiency > 97%



**TMB/TMB45/TMB60/TMB95 series (15kVA-20kVA)**

**FUNCTION PRESENTATION**



MODEL	TMB(15kVA/20kVA)	TMB45(15kVA/20kVA)	TMB60(15kVA/20kVA)	TMB95(15kVA/20kVA)
INPUT VOLTAGE	AC 130V-270V	AC 45V-280V	AC 60V-280V	AC 95V-280V
OUTPUT VOLTAGE	AC 220V±10% 50/60Hz			
DELAY TIME	Short Delay:3-5sec Long Deley:3-7min			
PROTECTION	Over Voltage(246V±4V),Overload,High Temperature,Short Circuit			
POWER	15000VA		20000VA	
PRODUCT SIZE(CM)	30x27x42.5		30x27x42.5	
PACKING SIZE(CM)	40x36.5x51.5		40x36.5x51.5	
PCS/CARTON	1		1	
N.W.(KGS)	30.1		32.5	
G.W.(KGS)	33.4		36.9	

**FUNCTION PRESENTATION**

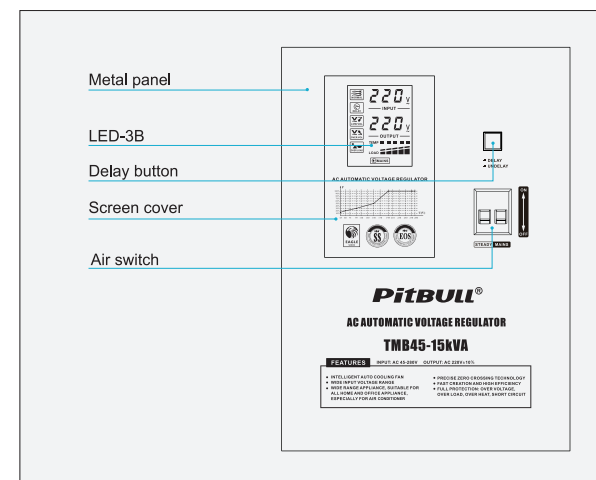

FRONT PANEL

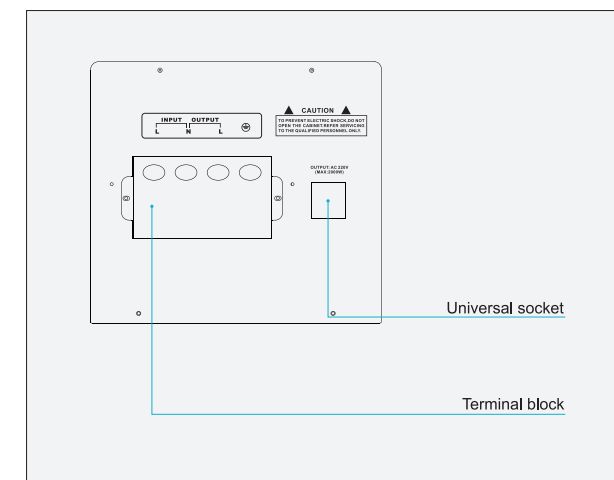

TOP



Relay Control+Toroidal Transformer, Efficiency > 97%

# TML/TML95 series (500VA-2000VA)

## PRODUCT FEATURES

The product of this model is a 220V fully automatic small-sized voltage regulator, with concise and generous appearance Display of LED digital design.it is characterized by small size, light weight and high pressure regulation speed.

## APPLICATION

It is widely used in various industries, small office equipment , refrigerator, electric fan, TV set, computer and other household appliances.

## PRODUCTS SPECIFICATION



MODEL	TML (500VA-2000VA)		TML95 (500VA-2000VA)	
INPUT VOLTAGE	AC 130V-270V		AC 95V-270V	
OUTPUT VOITAGE	AC 220V±10% 50/60Hz			
DELAY TIME	Short Delay:3-5sec Long Deley:3-7min			
PROTECTION	Over Voltage(246V±4V),Overload,High Temperature,Short Circuit			
POWER	500VA	1000VA	1500VA	2000VA
PRODUCT SIZE(CM)	25.5x11x16	28.5x15x19	28.5x15x19	28.5x15x19
PACKING SIZE(CM)	63.2x30.5x39	60x33x45	60x33x45	60x33x45
PCS/CARTON	8	6	6	6
N.W.(KGS)	21.9	23.6	30.2	33.7
G.W.(KGS)	22	26.2	33	35.8

## FUNCTION DISPLAY

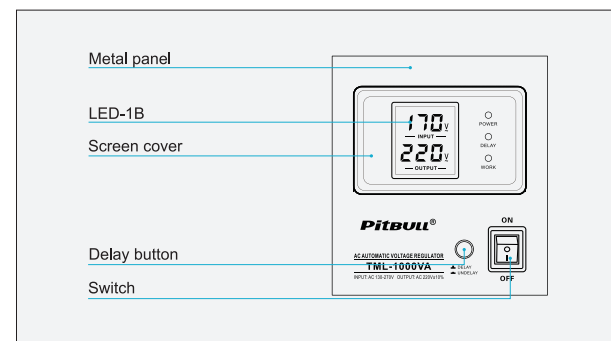

FRONT PANEL

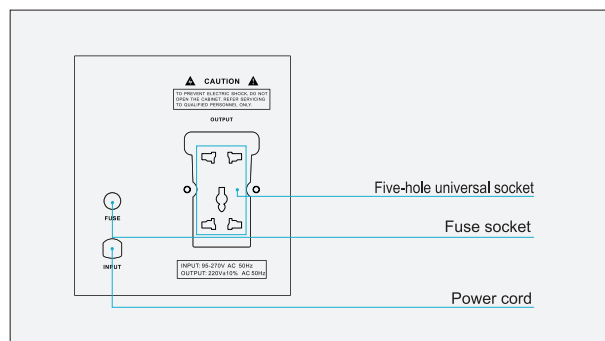

BACK PANEL



Relay Control+Toroidal Transformer,Efficiency > 97%

# TML/TML95 series (3000VA-10kVA)

## PRODUCT FEATURES

The product of this model is a 220V fully automatic voltage regulator,design of imitating computer case, with concise and generous appearance .Display of LED digital design.it is characterized by stable work, high pressure regulation speed and wide voltage regulation range.

## APPLICATION

It is widely used in various industries, small office equipment,refrigerator, electric fan, computer, pump, air conditioner and other household appliances.

## PRODUCTS SPECIFICATION



MODEL	TML (3000VA-10kVA)		TML95 (3000VA-10kVA)	
INPUT VOLTAGE	AC 130V-270V		AC 95V-270V / AC 95V-280V	
OUTPUT VOITAGE	AC 220V±10% 50/60Hz			
DELAY TIME	Short Delay:3-5sec Long Deley:3-7min			
PROTECTION	Over Voltage(246V±4V),Overload,High Temperature,Short Circuit			
POWER	3000VA	5000VA	8000VA	10000VA
PRODUCT SIZE(CM)	30x23x21.5	34.5x22.5x27.3	41.5x24x36	41.5x24x36
PACKING SIZE(CM)	59x36.5x29.5	40x28x34	47x30x42.5	47x30x42.5
PCS/CARTON	2	1	1	1
N.W.(KGS)	10.1	14.4	23.6	26
G.W.(KGS)	24.5	15.5	24.6	27

## FUNCTION DISPLAY

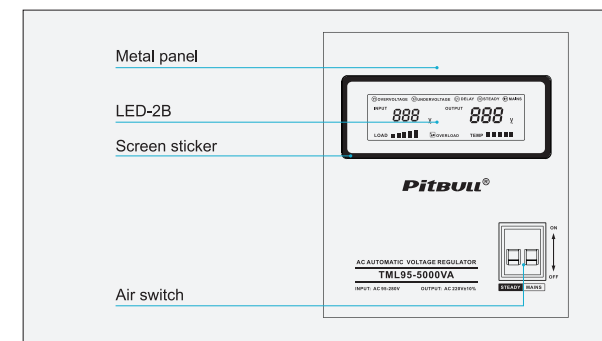

FRONT PANEL

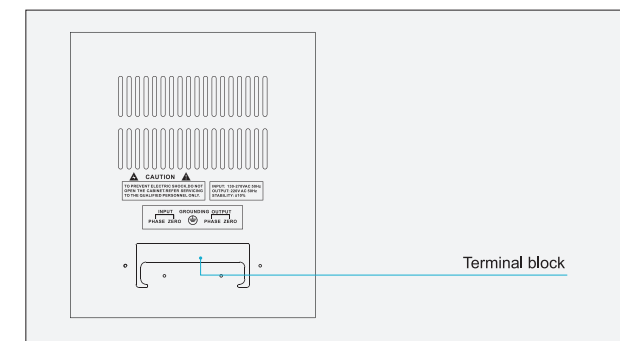

BACK PANEL



Relay Control+Toroidal Transformer,Efficiency > 97%

# TMH45/TMH60/TMH95 series (3000VA-10kVA)

## PRODUCT FEATURES

The product of this model is a 220V fully automatic voltage regulator, design of LED digital display, southeast Asian style and appearance. It is characterized by stable work, high pressure regulation speed and wide voltage regulation range.

## APPLICATION

It is widely used in various industries, small office equipment, refrigerator, electric fan, computer, pump, air conditioner and other household appliances.

## PRODUCTS SPECIFICATION



MODEL	TMH45 (3000VA-10kVA)	TMH60 (3000VA-10kVA)	TMH95 (3000VA-10kVA)
INPUT VOLTAGE	AC 45V-280V	AC 60V-280V	AC 95V-280V
OUTPUT VOLTAGE	AC 220V±10% 50/60Hz		
DELAY TIME	Short Delay:3-5sec		
PROTECTION	Over Voltage(246V±4V), Overload, High Temperature, Short Circuit		
POWER	3000VA	5000VA	10000VA
PRODUCT SIZE(CM)	39x26x35	39x26x35	39x26x35
PACKING SIZE(CM)	44x42.5x34.5	44x42.5x34.5	44x42.5x34.5
PCS/CARTON	1	1	1
N.W.(KGS)	18.5	20.4	26.4
G.W.(KGS)	24.6	26.5	32.4

## FUNCTION DISPLAY

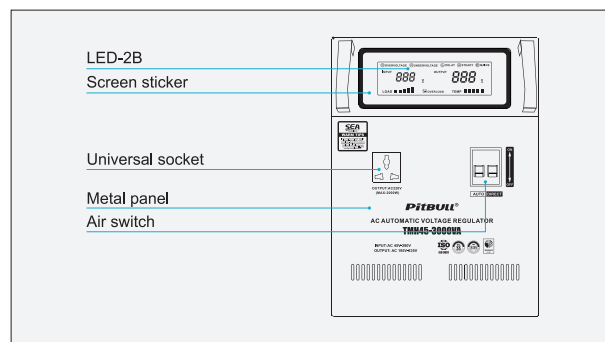

FRONT PANEL

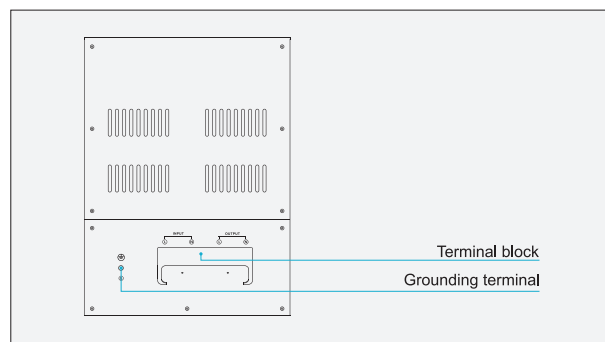

BACK PANEL



Relay Control+Toroidal Transformer, Efficiency > 97%



# TMH45/TMH60/TMH95 series (15kVA-20kVA)

## PRODUCT FEATURES

The product of this model is a 220V fully automatic voltage regulator, design of LED digital display, southeast Asian style and appearance. It is characterized by stable work, high pressure regulation speed and wide voltage regulation range.

## APPLICATION

It is widely used in various industries, small office equipment, refrigerator, electric fan, computer, pump, air conditioner and other household appliances.

## PRODUCTS SPECIFICATION



MODEL	TMH45 (15kVA-20kVA)	TMH60 (15kVA-20kVA)	TMH95 (15kVA-20kVA)
INPUT VOLTAGE	AC 45V-280V	AC 60V-280V	AC 95V-280V
OUTPUT VOLTAGE	AC 220V±10% 50/60Hz		
DELAY TIME	Short Delay:3-5sec		
PROTECTION	Over Voltage(246V±4V), Overload, High Temperature, Short Circuit		
POWER	15000VA		20000VA
PRODUCT SIZE(CM)	39x35x35		39x35x35
PACKING SIZE(CM)	45.5x41.5x44		45.5x41.5x44
PCS/CARTON	1		1
N.W.(KGS)	33.0		36.0
G.W.(KGS)	39.4		42.4

## FUNCTION DISPLAY

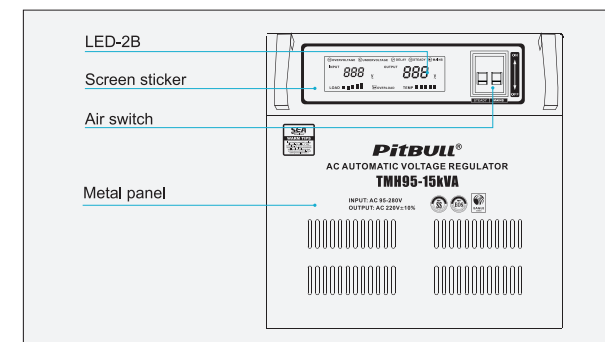

FRONT PANEL

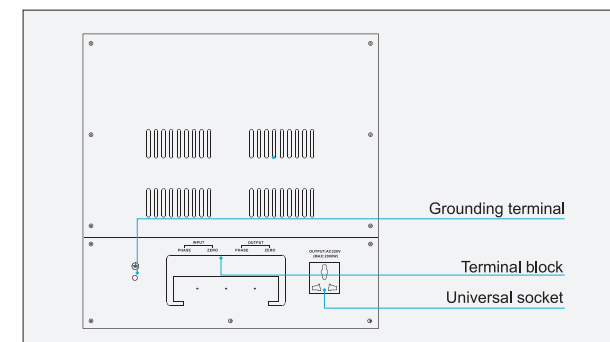

BACK PANEL



Relay Control+Toroidal Transformer, Efficiency > 97%



# TMH45/TMH60/TMH95 series (30kVA)

## PRODUCT FEATURES

The product of this model is a 220V fully automatic voltage regulator, design of LED digital display. it is characterized by stable work, high pressure regulation speed and wide voltage regulation range.

## APPLICATION

It is widely used in various industries, small office equipment, refrigerator, electric fan, computer, pump, air conditioner and other household appliances.

## PRODUCTS SPECIFICATION



MODEL	TMH45-30kVA	TMH60-30kVA	TMH95-30kVA
INPUT VOLTAGE	AC 45V-280V	AC 60V-280V	AC 95V-280V
OUTPUT VOITAGE	AC 220V±10% 50/60Hz		
DELAY TIME	Short Delay:3-5sec		
PROTECTION	Over Voltage(246V±4V), Overload, High Temperature, Short Circuit		
POWER	30000VA		
PRODUCT SIZE(CM)	45x41.5x52.2		
PACKING SIZE(CM)	51x47x66.5		
PCS/CARTON	1		
N.W.(KGS)	68.4		
G.W.(KGS)	73.2		

## FUNCTION DISPLAY

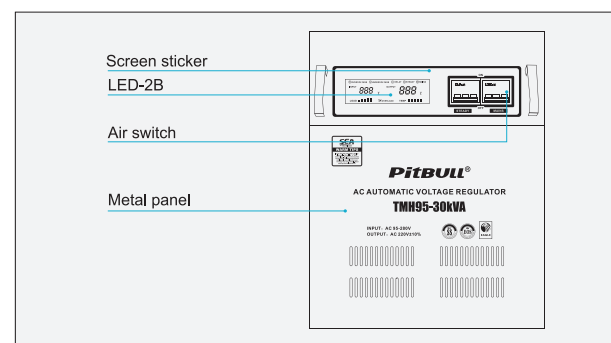

FRONT PANEL

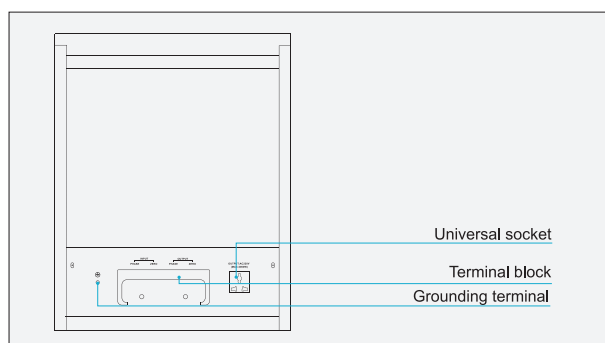

BACK PANEL



Relay Control+Toroidal Transformer, Efficiency > 97%

# TM/TM45/TM60/TM95 series (5000VA-15kVA)

## PRODUCT FEATURES

The product of this model is a 220V fully automatic voltage regulator, with Wall-mounted design, the appearance is concise and generous. Display of LED digital design. it is characterized by stable work, high pressure regulation speed and wide voltage regulation range.

## APPLICATION

Widely used in various industries, small office equipment and refrigerators, electric fans, air conditioning, television and other small appliances.

## PRODUCTS SPECIFICATION



MODEL	TM(5000VA-15kVA)	TM45(5000VA-15kVA)	TM60(5000VA-15kVA)	TM95(5000VA-15kVA)
INPUT VOLTAGE	AC 130V-270V	AC 45V-280V	AC 60V-280V	AC 95V-280V
OUTPUT VOITAGE	AC 220V±10% 50/60Hz			
DELAY TIME	Short Delay:3-5sec			
PROTECTION	Over Voltage(246V±4V), Overload, High Temperature, Short Circuit			
POWER	5000VA	10000VA	12000VA	15000VA
PRODUCT SIZE(CM)	44x32x21	44x32x21	44x32x21	44x32x21
PACKING SIZE(CM)	51x39x26	51x39x26	51x39x26	51x39x26
PCS/CARTON	1	1	1	1
N.W.(KGS)	16.5	21.7	23.2	24.5
G.W.(KGS)	17.8	23.3	24.5	26.4

## FUNCTION DISPLAY

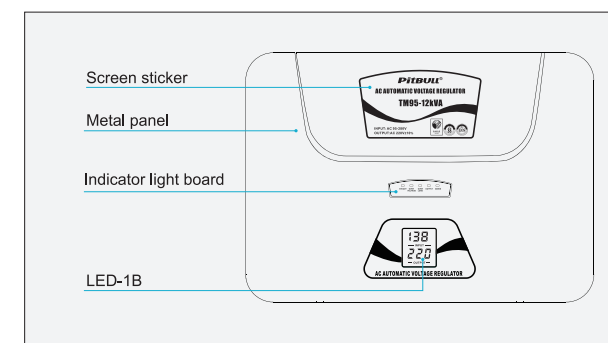

FRONT PANEL

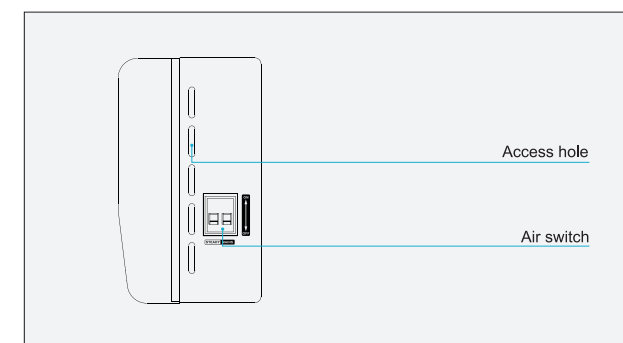

SIDE



Relay Control+Toroidal Transformer, Efficiency > 97%

# TME/TME95 series (3000VA-8000VA)

## PRODUCT FEATURES

The product of this model is a 220V fully automatic voltage regulator, with Wall-mounted design,the appearance is concise and generous.Display of LED digital design.it is characterized by stable work, high pressure regulation speed and wide voltage regulation range.

## APPLICATION

It is widely used in various industries, small office equipment,refrigerator, electric fan, computer, pump, air conditioner and other household appliances.

## PRODUCTS SPECIFICATION



MODEL	TME(3000VA-8000VA)	TME95(3000VA-8000VA)	
INPUT VOLTAGE	AC 130V-270V	AC 95V-280V	
OUTPUT VOITAGE	AC 220V±10% 50/60Hz		
DELAY TIME	Short Delay:3-5sec		
PROTECTION	Over Voltage(246V±4V),Overload,High Temperature,Short Circuit		
POWER	3000VA	5000VA	8000VA
PRODUCT SIZE(CM)	37.7x26.4x14.5	40.5x28.5x16.2	40.5x28.5x16.2
PACKING SIZE(CM)	42.5x30.5x20	45x34x21.7	45x34x21.7
PCS/CARTON	1	1	1
N.W.(KGS)	10.5	14.8	18.2
G.W.(KGS)	11.1	16	19

## FUNCTION DISPLAY

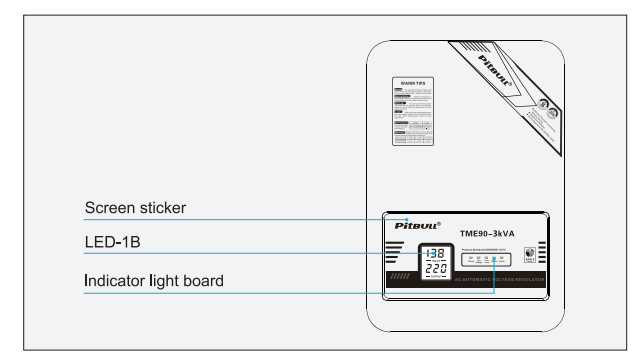

FRONT PANEL

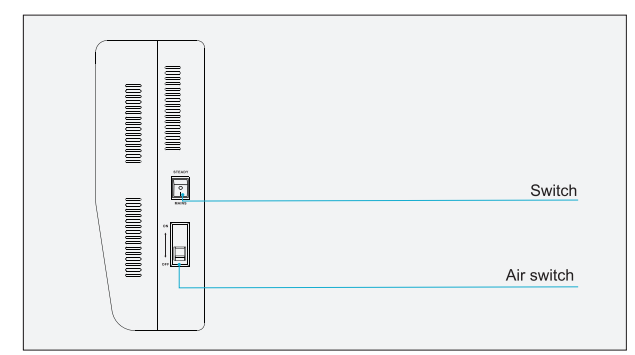

SIDE



Relay Control+Toroidal Transformer,Efficiency > 97%

# TME/TME95 series (10kVA-15kVA)

## PRODUCT FEATURES

The product of this model is a 220V fully automatic voltage regulator, with Wall-mounted design,the appearance is concise and generous.Display of LED digital design.it is characterized by stable work, high pressure regulation speed and wide voltage regulation range.

## APPLICATION

It is widely used in various industries, small office equipment,refrigerator, electric fan, computer, pump, air conditioner and other household appliances.

## PRODUCTS SPECIFICATION

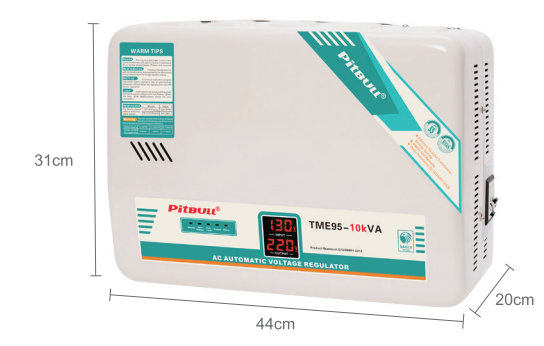

MODEL	TME(10kVA-15kVA)		TME95(10kVA-15kVA)
INPUT VOLTAGE	AC 130V-270V		AC 95V-280V
OUTPUT VOITAGE	AC 220V±10% 50/60Hz		
DELAY TIME	Short Delay:3-5sec		
PROTECTION	Over Voltage(246V±4V),Overload,High Temperature,Short Circuit		
POWER	10000VA	12000VA	15000VA
PRODUCT SIZE(CM)	44x31x20	44x31x20	44x31x20
PACKING SIZE(CM)	50x38x25	50x38x25	50x38x25
PCS/CARTON	1	1	1
N.W.(KGS)	21.6	23.3	24.6
G.W.(KGS)	23.1	24.7	21.6

## FUNCTION DISPLAY

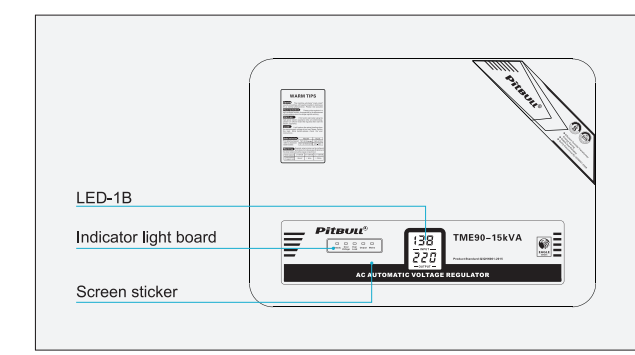

FRONT PANEL

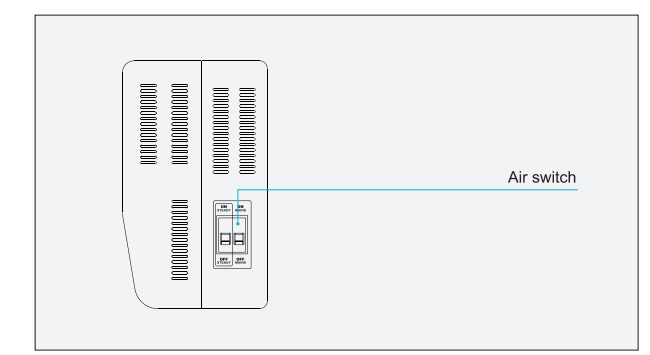

SIDE



Relay Control+Toroidal Transformer,Efficiency > 97%

# TMG/TMG95 series (15kVA-20kVA)

## PRODUCT FEATURES

The product of this model is a 220V fully automatic voltage regulator, design of LCD digital display and easy move. It is characterized by stable work, high pressure regulation speed and wide voltage regulation range.

## APPLICATION

It is widely used in various industries, small office equipment, refrigerator, electric fan, computer, pump, air conditioner and other household appliances.

## PRODUCTS SPECIFICATION



MODEL	TMG(15kVA/20kVA)	TMG95(15kVA/20kVA)
INPUT VOLTAGE	AC 130V-270V	AC 95V-280V
OUTPUT VOLTAGE	AC 220V±10% 50/60Hz	
DELAY TIME	Short Delay:3-5sec	
PROTECTION	Over Voltage(246V±4V),Overload,High Temperature,Short Circuit	
POWER	15000VA	20000VA
PRODUCT SIZE(CM)	34.5x31.5x57.5	34.5x31.5x57.5
PACKING SIZE(CM)	40.5x37.5x66	40.5x37.3x66
PCS/CARTON	1	1
N.W.(KGS)	30.5	33.5
G.W.(KGS)	36.8	39.7

## FUNCTION DISPLAY

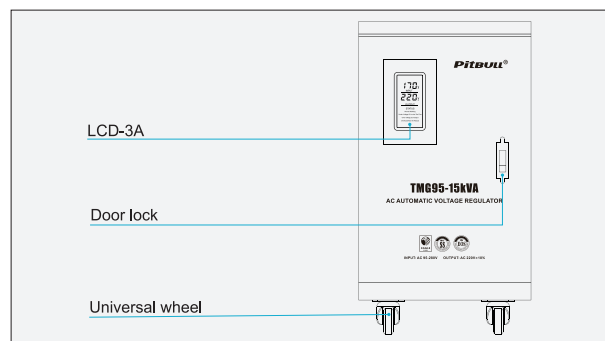

FRONT PANEL

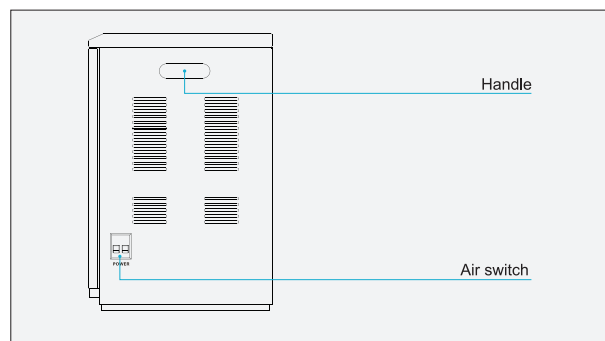

SIDE



Relay Control+Toroidal Transformer, Efficiency > 97%

# SVC50 series (3000VA-10kVA)

## PRODUCT FEATURES

The product of this model is a high-precision regulator, with desktop design, using motor-driven carbon brush sliding between turns of self-coupling transformer winding and directly adjust the output voltage. It is characterized by high-precision output, wide input voltage range.

## APPLICATION

It is widely used in various industries, small office equipment, refrigerator, electric fan, computer, pump, air conditioner and other household appliances.

## PRODUCTS SPECIFICATION



MODEL	SVC50(3000VA-10kVA)			
INPUT VOLTAGE	AC 50V-250V			
OUTPUT VOLTAGE	AC 110V / 220V±1~3% 50/60Hz			
DELAY TIME	Short Delay:3-5sec			
PROTECTION	Over Voltage(246V±4V),Overload,High Temperature,Short Circuit			
POWER	3000VA	5000VA	8000VA	10000VA
PRODUCT SIZE(CM)	41x26.5x39	41x26.5x39	43x32.5x45.1	43x32.5x45.1
PACKING SIZE(CM)	49x32x48	49x32x48	51x38x54	51x38x54
PCS/CARTON	1	1	1	1
N.W.(KGS)	28.3	30.8	38.5	42.8
G.W.(KGS)	35	37.5	45.9	50.7

## FUNCTION DISPLAY

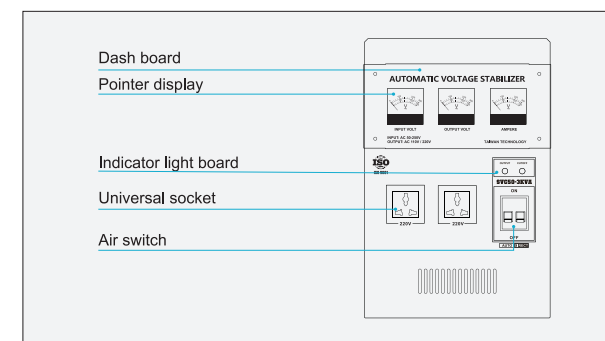

FRONT PANEL

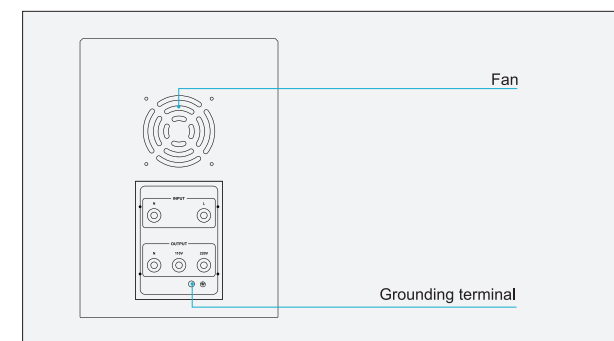

BACK PANEL



Servo Motor Control+Toroidal Transformer, Efficiency > 97%

# SVC series (500VA-1500VA)

## PRODUCT FEATURES

The product of this model is a high-precision regulator, both for desktop and wall mounted, with LED digital display design, using motor-driven carbon brush sliding between turns of self-coupling transformer winding and directly adjust the output voltage. It is characterized by small size, light weight and high-precision output.

## APPLICATION

It is widely used in industrial production, scientific research, health care, household appliances which are with large fluctuation of grid voltage or the area with large seasonal grid voltage. It can provide high-quality power to any load.

## PRODUCTS SPECIFICATION



MODEL	SVC (500VA-1500VA)		
INPUT VOLTAGE	AC 100V-260V		
OUTPUT VOLTAGE	AC 220V±1~3% 50/60Hz		
DELAY TIME	Short Delay:3-5sec		
PROTECTION	Over Voltage(246V±4V), Overload, High Temperature, Short Circuit		
POWER	500VA	1000VA	1500VA
PRODUCT SIZE(CM)	30x15.5x20	30x15.5x20	30x15.5x20
PACKING SIZE(CM)	39.5x35x50	39.5x35x50	39.5x35x50
PCS/CARTON	4	4	4
N.W.(KGS)	10.3	13.6	18.9
G.W.(KGS)	12.3	15.8	20.5

## FUNCTION DISPLAY

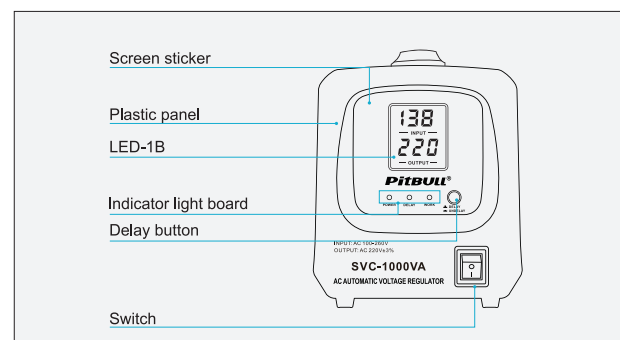

FRONT PANEL

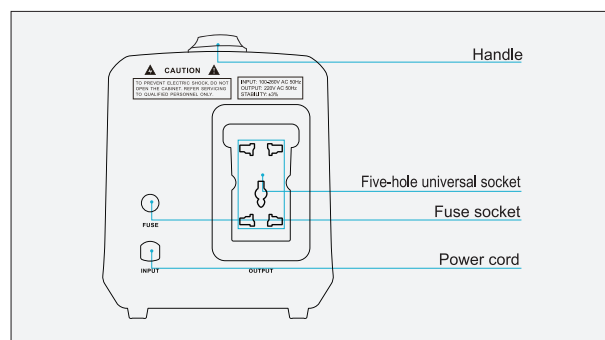

BACK PANEL



Servo Motor Control+Toroidal Transformer, Efficiency > 97%

# SVC series (2000VA-10kVA)

## PRODUCT FEATURES

The product of this model is a high-precision regulator, both for desktop and wall mounted, with LCD digital display design, using motor-driven carbon brush sliding between turns of self-coupling transformer winding and directly adjust the output voltage. It is characterized by high-precision output.

## APPLICATION

It is widely used in industrial production, scientific research, health care, household appliances which are with large fluctuation of grid voltage or the area with large seasonal grid voltage. It can provide high-quality power to any load.

## PRODUCTS SPECIFICATION



MODEL	SVC (2000VA-10kVA)				
INPUT VOLTAGE	AC 100V-260V / 130-250V				
OUTPUT VOLTAGE	AC 220V±1~3% 50/60Hz				
DELAY TIME	Short Delay:3-5sec				
PROTECTION	Over Voltage(246V±4V), Overload, High Temperature, Short Circuit				
POWER	2000VA	3000VA	5000VA	8000VA	10000VA
PRODUCT SIZE(CM)	28.5x23.7x18.5	30x23x21.5	34.5x22.5x27.3	41.5x24x36	41.5x24x36
PACKING SIZE(CM)	34.5x29x23.5	35.5x28.5x27.5	40x28x34	47x30x42.5	47x30x42.5
PCS/CARTON	1	1	1	1	1
N.W.(KGS)	9.0	12.5	16.5	20.6	27.2
G.W.(KGS)	9.8	13.3	17.3	21.6	28.4

## FUNCTION DISPLAY

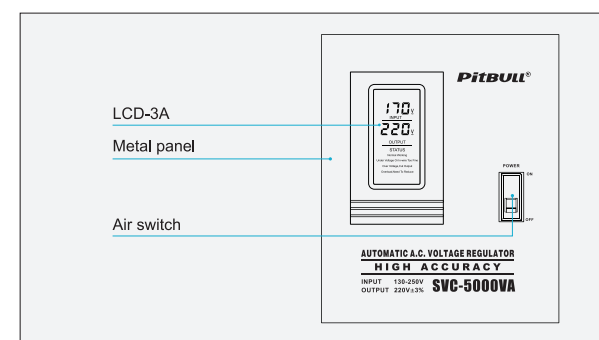

FRONT PANEL

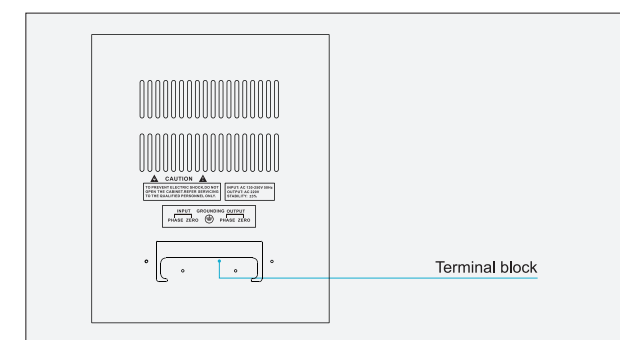

BACK PANEL



Servo Motor Control+Toroidal Transformer, Efficiency > 97%

## SVC-M series (1000VA-1500VA)

### PRODUCT FEATURES

The product of this model is a high-precision regulator, with LED digital display design, using motor-driven carbon brush sliding between turns of self-coupling transformer winding and directly adjust the output voltage. It is characterized by small size, light weight and high-precision output.

### APPLICATION

It is widely used in industrial production, scientific research, health care, household appliances which are with large fluctuation of grid voltage or the area with large seasonal grid voltage. It can provide high-quality power to any load.

### PRODUCTS SPECIFICATION



MODEL	SVC-M (500VA-1500VA)		
INPUT VOLTAGE	AC 100V-260V / 130V-250V		
OUTPUT VOITAGE	AC 220V±1~3% 50/60Hz		
DELAY TIME	Short Delay:3-5sec Long Deley:3-7min		
PROTECTION	Over Voltage(246V±4V),Overload,High Temperature,Short Circuit		
POWER	500VA	1000VA	1500VA
PRODUCT SIZE(CM)	25.5x11x16	28.5x15x19	28.5x15x19
PACKING SIZE(CM)	63.2x30.5x39	60x33x45	60x33x45
PCS/CARTON	8	6	6
N.W.(KGS)	21.9	23.6	30.2
G.W.(KGS)	22	26.2	33

### FUNCTION DISPLAY

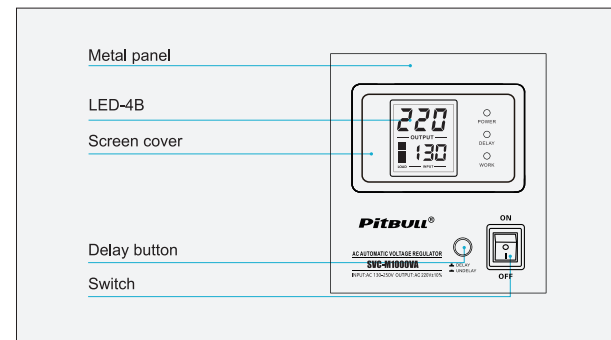

FRONT PANEL

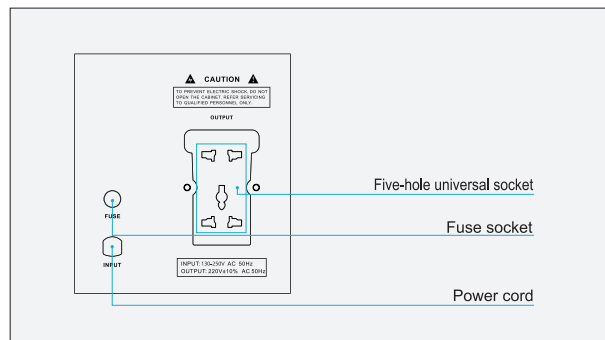

BACK PANEL



Servo Motor Control+Toroidal Transformer, Efficiency > 97%

## SVC-M series (2000VA-10kVA)

### PRODUCT FEATURES

The product of this model is a high-precision regulator, both for desktop and wall mounted, with LED/LCD digital display design, using motor-driven carbon brush sliding between turns of self-coupling transformer winding and directly adjust the output voltage. It is characterized by high-precision output.

### APPLICATION

It is widely used in industrial production, scientific research, health care, household appliances which are with large fluctuation of grid voltage or the area with large seasonal grid voltage. It can provide high-quality power to any load.

### PRODUCTS SPECIFICATION



MODEL	SVC-M (2000VA-10kVA)				
INPUT VOLTAGE	AC 100V-260V / 130-250V				
OUTPUT VOITAGE	AC 220V±1~3% 50/60Hz				
DELAY TIME	Short Delay:3-5sec				
PROTECTION	Over Voltage(246V±4V),Overload,High Temperature,Short Circuit				
POWER	2000VA	3000VA	5000VA	8000VA	10000VA
PRODUCT SIZE(CM)	28.5x23.7x18.5	30x23x21.5	34.5x22.5x27.3	41.5x24x36	41.5x24x36
PACKING SIZE(CM)	34.5x29x23.5	34.5x39x23.5	40x28x34	47x30x42.5	47x30x42.5
PCS/CARTON	1	1	1	1	1
N.W.(KGS)	9.0	12.5	16.3	20.6	27.0
G.W.(KGS)	9.8	13.3	17.1	21.6	28.0

### FUNCTION DISPLAY

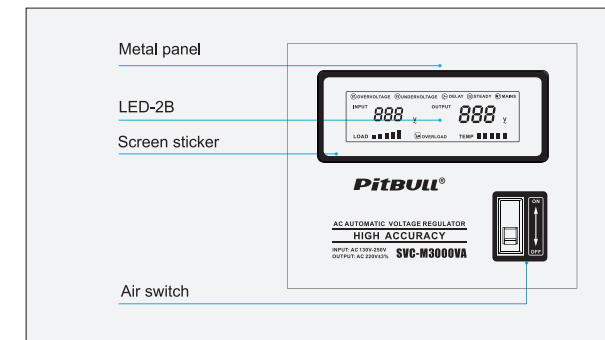

FRONT PANEL

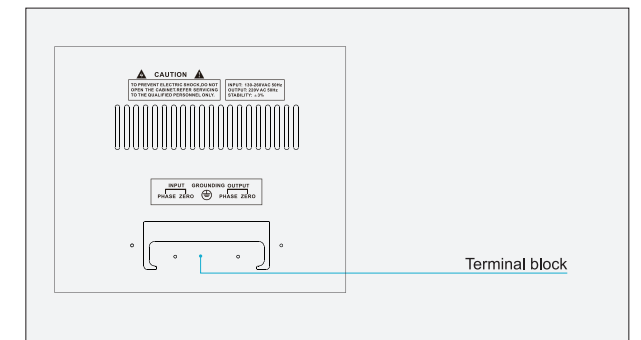

BACK PANEL



Servo Motor Control+Toroidal Transformer, Efficiency > 97%

# PC-SVC series (3000VA-10kVA)

## PRODUCT FEATURES

The product of this model is a high-precision regulator, both for desktop and wall mounted, with LED digital display design, using motor-driven carbon brush sliding between turns of self-coupling transformer winding and directly adjust the output voltage, two kinds of output voltage 110V/220V.

## PRODUCTS SPECIFICATION



MODEL	PC-SVC-3kVA
INPUT VOLTAGE	AC 100V-260V / 130V-250V
OUTPUT VOITAGE	AC 220V±1~3% 50/60Hz
DELAY TIME	Short Delay:3-5sec Long Deley:3-7min
PROTECTION	Over Voltage(246V±4V),Overload,High Temperature,Short Circuit
POWER	3000VA
PRODUCT SIZE(CM)	33.5x24.5x15.5
PACKING SIZE(CM)	38.5x33.5x21.2
PCS/CARTON	1
N.W.(KGS)	13.2
G.W.(KGS)	13.8



MODEL	PC-SVC-5kVA
INPUT VOLTAGE	AC 100V-260V / 130V-250V
OUTPUT VOITAGE	AC 220V±1~3% 50/60Hz
DELAY TIME	Short Delay:3-5sec Long Deley:3-7min
PROTECTION	Over Voltage(246V±4V),Overload,High Temperature,Short Circuit
POWER	5000VA
PRODUCT SIZE(CM)	36.5x27x17.5
PACKING SIZE(CM)	41.5x36.5x24.5
PCS/CARTON	1
N.W.(KGS)	17.5
G.W.(KGS)	18.3



Servo Motor Control+Toroidal Transformer,Efficiency > 97%



## APPLICATION

It is widely used in various industries, small office equipment,refrigerator, electric fan, computer, pump, air conditioner and other household appliances.

## PRODUCTS SPECIFICATION



MODEL	PC-SVC-8kVA	PC-SVC-10kVA
INPUT VOLTAGE	AC 100V-260V / 130V-250V	
OUTPUT VOITAGE	AC 220V±1~3% 50/60Hz	
DELAY TIME	Short Delay:3-5sec Long Deley:3-7min	
PROTECTION	Over Voltage(246V±4V),Overload,High Temperature,Short Circuit	
POWER	8000VA	10000VA
PRODUCT SIZE(CM)	39.6x29.7x19	39.6x29.7x19
PACKING SIZE(CM)	45x39.5x25.7	45x39.5x25.7
PCS/CARTON	1	1
N.W.(KGS)	22	24.6
G.W.(KGS)	22.8	25.4

## FUNCTION DISPLAY

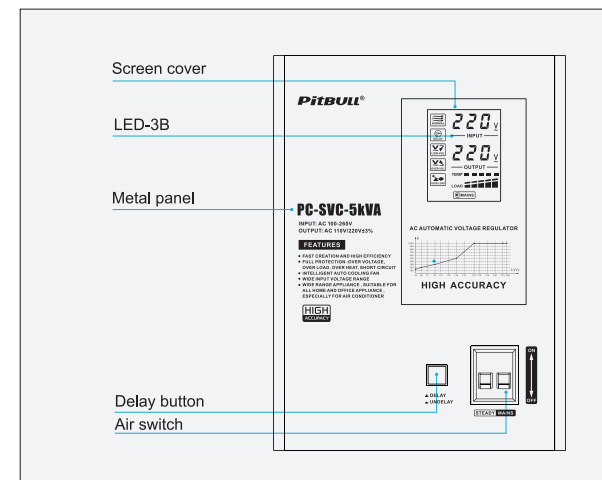

FRONT PANEL

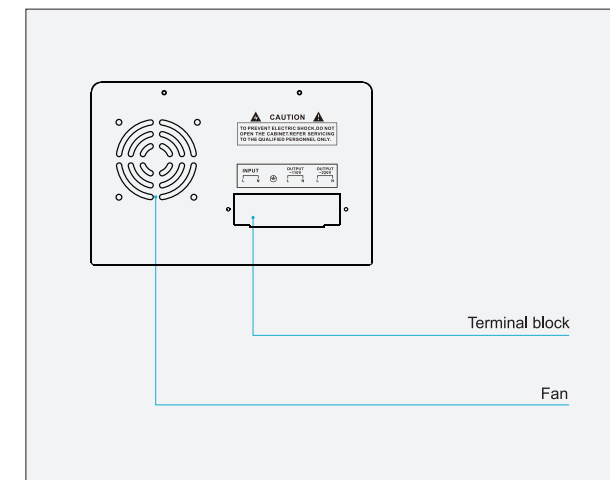

TOP



Servo Motor Control+Toroidal Transformer,Efficiency > 97%

# TND series (10kVA-50kVA)

## PRODUCT FEATURES

The product of this model is a high-precision regulator, cabinet type with LED digital display design. It is mainly composed of voltage regulation transformer and compensation transformer and characterized by sufficient power, can achieve relatively large power and maintain high-precision output.

## APPLICATION

It is widely used in industrial and mining enterprises, printing, machine tools, post and telecommunications, railways, construction sites, schools, hospitals, hotels, defense, scientific research and other departments of electronic computers, precision machine tools, precision instruments, experimental devices, Elevators and production lines all places where voltage stability is required.

## PRODUCTS SPECIFICATION



**SINGLE PHASE**

MODEL	TND(10kVA-20kVA)		
INPUT VOLTAGE	AC 80V-260V / 100V-260V / 130-260V		
OUTPUT VOITAGE	AC 220V±1~3% 50/60Hz		
DELAY TIME	Short Delay:3-5sec		
PROTECTION	Over Voltage(246V±4V),Overload,High Temperature,Short Circuit		
POWER	10000VA	15000VA	20000VA
PRODUCT SIZE(CM)	38x35x66.5	38x35x66.5	38x35x66.5
PACKING SIZE(CM)	44x40x75	44x40x75	44x40x75
PCS/CARTON	1	1	1
N.W.(KGS)	60.7	62	62
G.W.(KGS)	66.7	68	68



Servo Motor Control+Toroidal Transformer, Efficiency > 97%



## PRODUCTS SPECIFICATION



**SINGLE PHASE**

MODEL	TND (20kVA-50kVA)			
INPUT VOLTAGE	AC 80V-260V / 100V-260V / 130-260V			
OUTPUT VOITAGE	AC 220V±1~3% 50/60Hz			
DELAY TIME	Short Delay:3-5sec			
PROTECTION	Over Voltage(246V±4V),Overload,High Temperature,Short Circuit			
POWER	20000VA	30000VA	40000VA	50000VA
PRODUCT SIZE(CM)	45x50x96.5	45x50x96.5	55x50x116.5	55x50x116.5
PACKING SIZE(CM)	56x51x103	56x51x103	61.5x56x123	61.5x56x123
PCS/CARTON	1	1	1	1
N.W.(KGS)	103	137	165	179
G.W.(KGS)	113	147	176	190

## FUNCTION DISPLAY

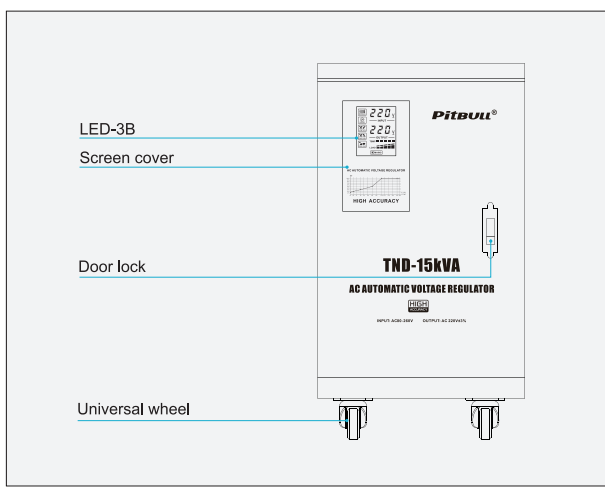

TND-15kVA

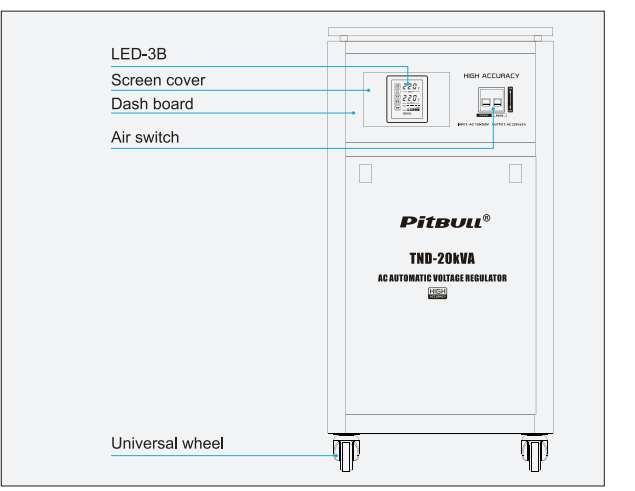

TND-20kVA



Servo Motor Control+Toroidal Transformer, Efficiency > 97%

# TNS series (9kVA-30kVA)

## PRODUCT FEATURES

The product of this model is a high-precision regulator, cabinet type design. With single phase voltage regulation. Pointer display/Digital display selection.

## APPLICATION

It is widely used in industrial and mining enterprises, printing, machine tools, post and telecommunications, railways, construction sites, schools, hospitals, hotels, defense, scientific research and other departments of electronic computers, precision machine tools, precision instruments, experimental devices, Elevators and production lines all places where voltage stability is required.

## PRODUCTS SPECIFICATION



**THREE PHASE** HIGH ACCURACY

MODEL	TNS (9kVA-30kVA)			
INPUT VOLTAGE	AC 260V-456V			
OUTPUT VOITAGE	AC 380V±1~3% 50/60Hz			
DELAY TIME	Short Delay:3-5sec			
PROTECTION	Over Voltage,Overload,High Temperature,Short Circuit			
POWER	9000VA	15000VA	20000VA	30000VA
PRODUCT SIZE(CM)	32x40.9x75.4	33.7x41x81.2	37.7x44.1x102	37.7x44.1x102
PACKING SIZE(CM)	38x46.9x83.9	39.7x47x89.7	43.7x50.1x108.5	43.7x50.1x108.5
PCS/CARTON	1	1	1	1
N.W.(KGS)	38.6	48	75	101.5
G.W.(KGS)	43.7	54	83.5	115.5



Servo Motor Control+Toroidal Transformer, Efficiency >97%

## PRODUCTS SPECIFICATION



**THREE PHASE** HIGH ACCURACY

MODEL	TNS (9kVA-30kVA)			
INPUT VOLTAGE	AC 260V-456V			
OUTPUT VOITAGE	AC 380V±1~3% 50/60Hz			
DELAY TIME	Short Delay:3-5sec			
PROTECTION	Over Voltage,Overload,High Temperature,Short Circuit			
POWER	9000VA	15000VA	20000VA	30000VA
PRODUCT SIZE(CM)	32x40.9x75.4	33.7x41x81.2	37.7x44.1x102	37.7x44.1x102
PACKING SIZE(CM)	38x46.9x83.9	39.7x47x89.7	43.7x50.1x108.5	43.7x50.1x108.5
PCS/CARTON	1	1	1	1
N.W.(KGS)	38.6	48	75	101.5
G.W.(KGS)	43.7	54	83.5	115.5

## FUNCTION DISPLAY

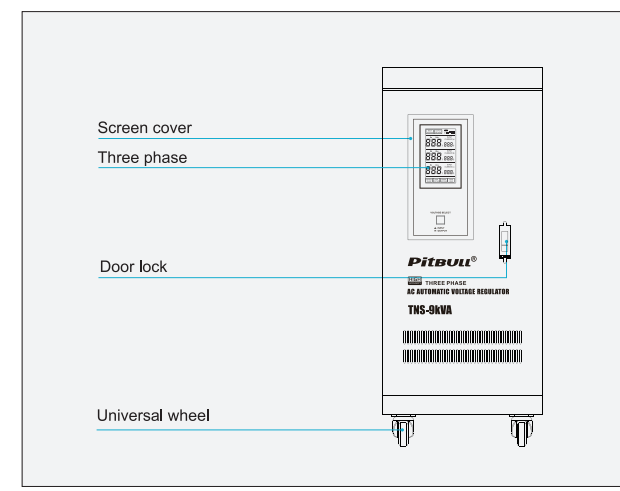

TND-15kVA

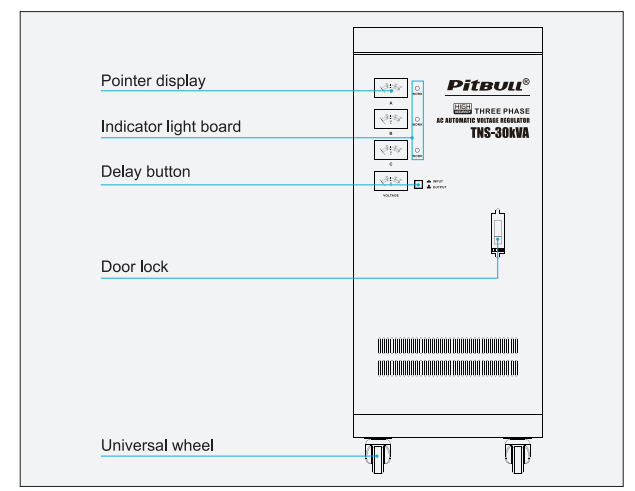

TND-20kVA



Servo Motor Control+Toroidal Transformer, Efficiency >97%



# TNS-B series (15kVA-60kVA)

## PRODUCT FEATURES

The product of this model is a three phase compensation high-precision regulator, cabinet type with LED digital display design, compensated structure voltage regulation. It is mainly composed of voltage regulation transformer and compensation transformer and characterized by sufficient power, can achieve relatively large power and maintain high-precision output.

## APPLICATION

It is widely used in industrial and mining enterprises, printing, machine tools, post and telecommunications, railways, construction sites, schools, hospitals, hotels, defense, scientific research and other departments of electronic computers, precision machine tools, precision instruments, experimental devices, Elevators and production lines all places where voltage stability is required.

## PRODUCTS SPECIFICATION

**HIGH ACCURACY** THREE PHASE

MODEL	TNS-B (15kVA-60kVA)					
INPUT VOLTAGE	AC 260V-456V					
OUTPUT VOITAGE	AC 380V±1~3% 50/60Hz					
DELAY TIME	Short Delay:3-5sec					
PROTECTION	Over Voltage, Overload, High Temperature, Short Circuit					
POWER	15000VA	20000VA	30000VA	40000VA	50000VA	60000VA
PRODUCT SIZE(CM)	48.5x49.5x100	59.5x49x111	75x63x136			
PACKING SIZE(CM)	55.5x55x103	66x55.5x134	84.5x72.5x144			
PCS/CARTON	1	1	1	1	1	1
N.W.(KGS)	86	108.5	125	170	190	196
G.W.(KGS)	94	116.5	135	183	203	209

## FUNCTION DISPLAY

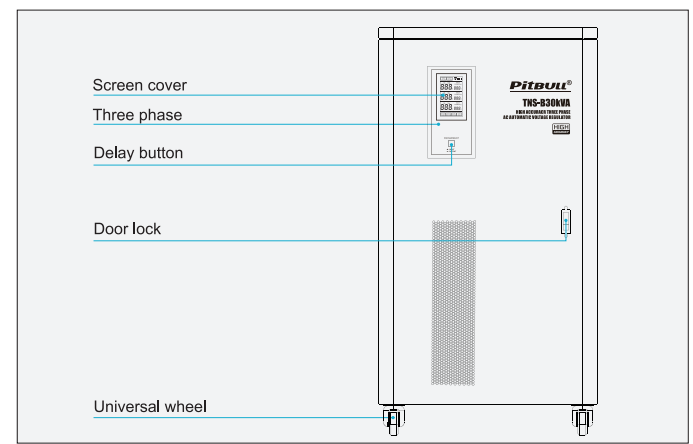

Servo Motor Control+Toroidal Transformer, Efficiency > 97%

# HIGH-ACCURACY

Protect Your Equipment Against The Damage From Power Fluctuation. Pitbull Avr, Your Intimate Equipment Guards!

**HIGH ACCURACY**



# AC AUTOMATIC VOLTAGE REGULATOR

# SBW series (50kVA-200kVA)

## PRODUCT FEATURES

The product of this model is cabinet type design, pointer display/digital display selection. It is characterized high-precision output. Suitable for a wide range of load, can withstand instantaneous overload. Long-term continuous work can be carried out, manual/ automatic switching and the automatic protection for over voltage, phase loss, phase sequence and mechanical failure are provided.

## PRODUCTS SPECIFICATION

<b>Technology</b>	Servo Motor Control+Toroidal Transformer, Efficiency >97%
<b>Input Voltage</b>	175Vac-265Vac (phase voltage) 300Vac-456Vac(line voltage)
<b>Output Voltage</b>	Single phase: 220Vac Three phase:380Vac
<b>Output Accuracy</b>	(1%~5%)
<b>Protection</b>	Over Voltage, Overload, High Temperature, Short Circuit(with fuse or circuit breaker)
<b>Operating Temperature</b>	-20~50°C
<b>Operating Relative Humidity</b>	10%RH-102%RH: non condensing

Model	Packing Size(cm)	G.W.(KGS)	QTY/40FT
SBW-50KVA	90 × 64 × 143	250	64
SBW-60KVA	90 × 64 × 143	255	64
SBW-100KVA	95 × 72 × 159	357	48
SBW-150KVA	95 × 72 × 159	482	48
SBW-200KVA	95 × 72 × 159	562	48
SBW-250KVA	107 × 80 × 180	710	34
SBW-300KVA	110 × 80 × 195	755	28
SBW-320KVA	110 × 80 × 195	810	28
SBW-400KVA	100 × 80 × 200(2cases)	1175	30
SBW-500KVA	100 × 80 × 200(2cases)	1510	30
SBW-600KVA	100 × 80 × 200(2cases)	1790	30
SBW-F800KVA	85 × 110 × 200(3cases)	2750	28
SBW-F1000KVA	85 × 110 × 200(3cases)	2780	28
SBW-F1200KVA	85 × 110 × 200(3cases)	4050	28
SBW-F1600KVA	120 × 120 × 220(4cases)	5500	17
SBW-F2000KVA	130 × 120 × 220(4cases)	7050	15

Standard Export Wooden Package



Servo Motor Control+Toroidal Transformer, Efficiency >97%



## APPLICATION

It is widely used in industrial and mining enterprises, printing, machine tools, post and telecommunications, railways, construction sites, schools, hospitals, hotels, defense, scientific research and other departments of electronic computers, precision machine tools, precision instruments, experimental devices, Elevators and production lines all places where voltage stability is required.

### HIGH ACCURACY THREE PHASE

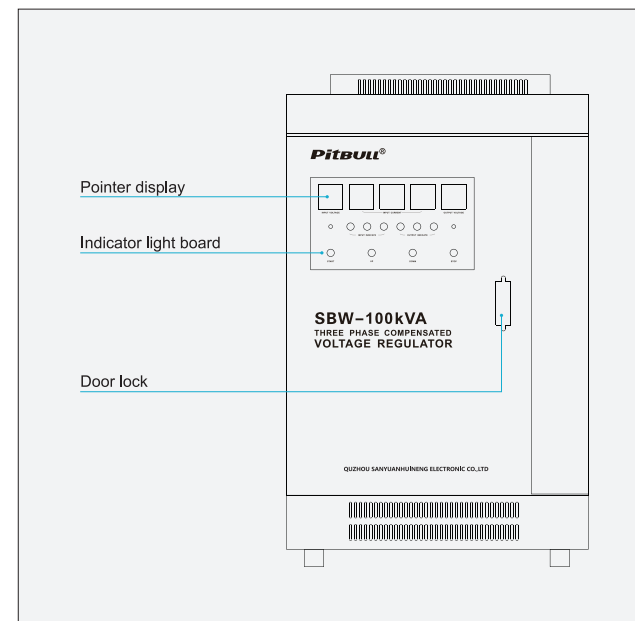

Servo Motor Control+Toroidal Transformer, Efficiency >97%

# Toroidal Transformer

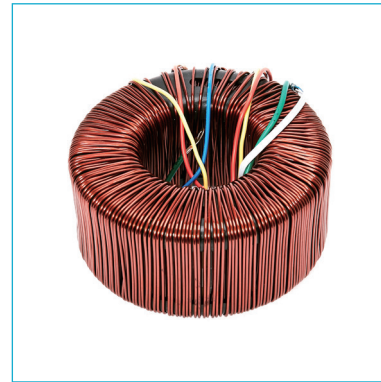
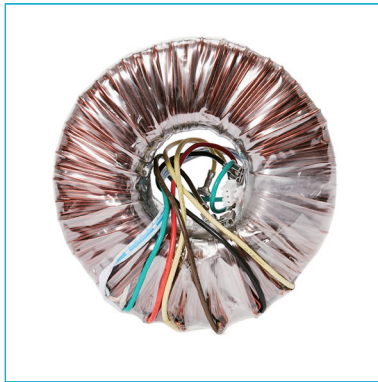

# Toroidal Core

